

112.20

Operating instruction Fine boring heads EWE 2-32 Digital

Important:

The digital display ⑧ always shows the dimensional change to the previously set value or to „0“. The absolute value can not be shown. Make dimensional corrections only with digital display switched on and with the tool holder ① assembled to the boring head.

Fig. 1

Preparation and presetting of the boring tool

Put the cutting tool (①+②), if necessary by using a reduction sleeve, into the boring head. Align the cutting edge ② by the mark on the face ③ of the boring head and tighten the two clamp screws ④. Unlock the tool carrier by loosening the clamp screw ⑤. Adjust the desired diameter on a presetter by the adjustment disc ⑥. Lock the tool carrier with clamp screw ⑤.

Fig. 2

Carry out dimensional corrections

Switch on digital display by pressing button ⑦. The display ⑧ shows the previously stored value. Press button ⑦ 1s to reset the value to "0". Loosen clamp screw ⑤ to unlock tool carrier. Correct the dimension (difference between actual and nominal diameter) by turning the adjustment disc ⑥. Lock tool carrier with clamp screw ⑤.

Fig. 3

When the battery level is too low, the tool display ⑧ will show the „Accu“ message for a few seconds. This message indicates that the CR1025 ⑩ battery must be replaced. The tool can still be operational for a few hundred times more, but we recommend replacing the battery as soon as the "Accu" sign is shown for the first time.







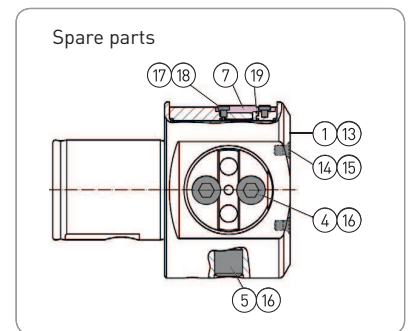
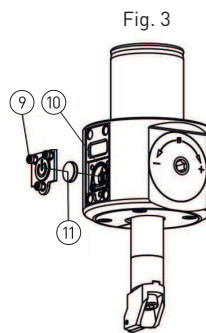
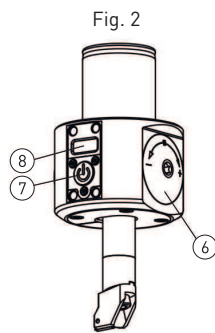
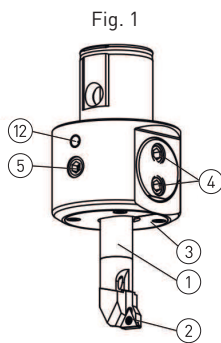

Procedure for battery replacement:

Make the tool perfectly dry before replacing the battery. If possible, apply some air pressure around the edges of the battery lid ⑩ in order to remove any water trapped between the lid and the main body. Remove the three screws ⑨ and the battery lid, taking care to not let any water drops fall inside the battery compartment or in the lower side of the battery cover. Use a clean cloth with alcohol to remove any oil or water from the lower side of the battery lid ⑦. For battery exchange please remove the old battery and wait two minutes before placing the new one. This will ensure a complete internal reset. Make sure the O-ring is correctly placed before closing the battery lid. Place the battery lid and tighten the three screws.

General Information

- Clean fine boring head with coolant lubricant, Alcohol or NEOVAL®
- Do not use any dissolvent cleaning media nor ultrasonic devices.
- Max. coolant pressure: 40 bar (580 psi)
- Operating temperature: +10°C to +40°C (50°F to 104°F)
- Storage temperature: 0°C to +40°C (32°F to 104°F)
- Note that the tool carrier travel is limited. Do NOT use excessive force when adjusting.
- Periodic lubrication (every 20 operating hours approx.) via the lube nipple ⑫ ensures high precision combined with long life. Light machine oil is recommended, e.g. Mobil Vactra Oil No. 2, BP Energol HLP-D32, Klueber Isoflex PDP 94.
- Protection category DIN 40050: IP 69K
- Fine boring head can be connected with a smartphone or a tablet. Download the app "BIG KAISER" for iOS or Android devices in the app stores.
- Check the disclaimer in the app.

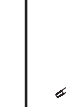

									
112.371	690.611	690.836	690.460	690.996	690.814	690.326	694.808	395.170	395.161
			M [Nm]: 5	M [Nm]: 5		M [Nm]: 1			
			M [ft-lbs.]: 4	M [ft-lbs.]: 4					