

SIMPLE VISION

HELP ON LINE

speroni
precision by design

since
1963

THE HOMING WINDOW

When you open the Speroni SIMPLEvision you see the Homing window:

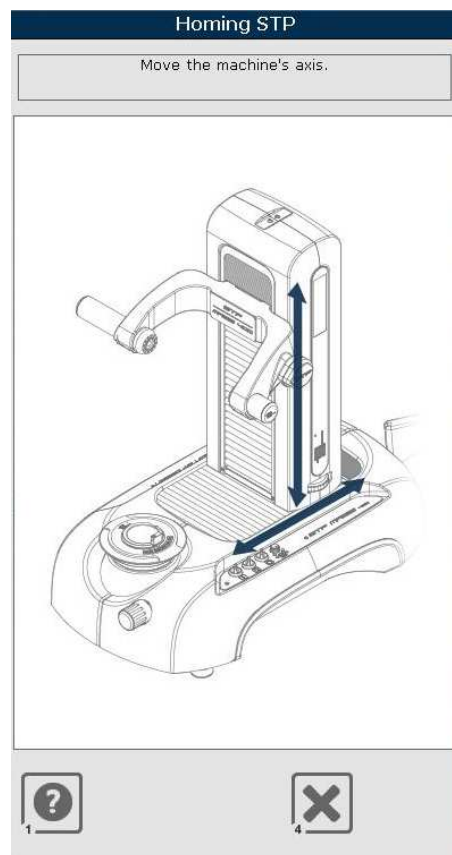

The green rows on the machine show you to move the axis. The machine takes the origin and the window disappears.

In this window there is the possibility to cancel the Homing procedure with the **Cancel** button



If you cancel the Homing procedure SIMPLEvision shows you a message like this:



Push the **Help** button  to show the Help window.



THE MAIN WINDOW

After the procedure of "taking Origins", you will see the main window.

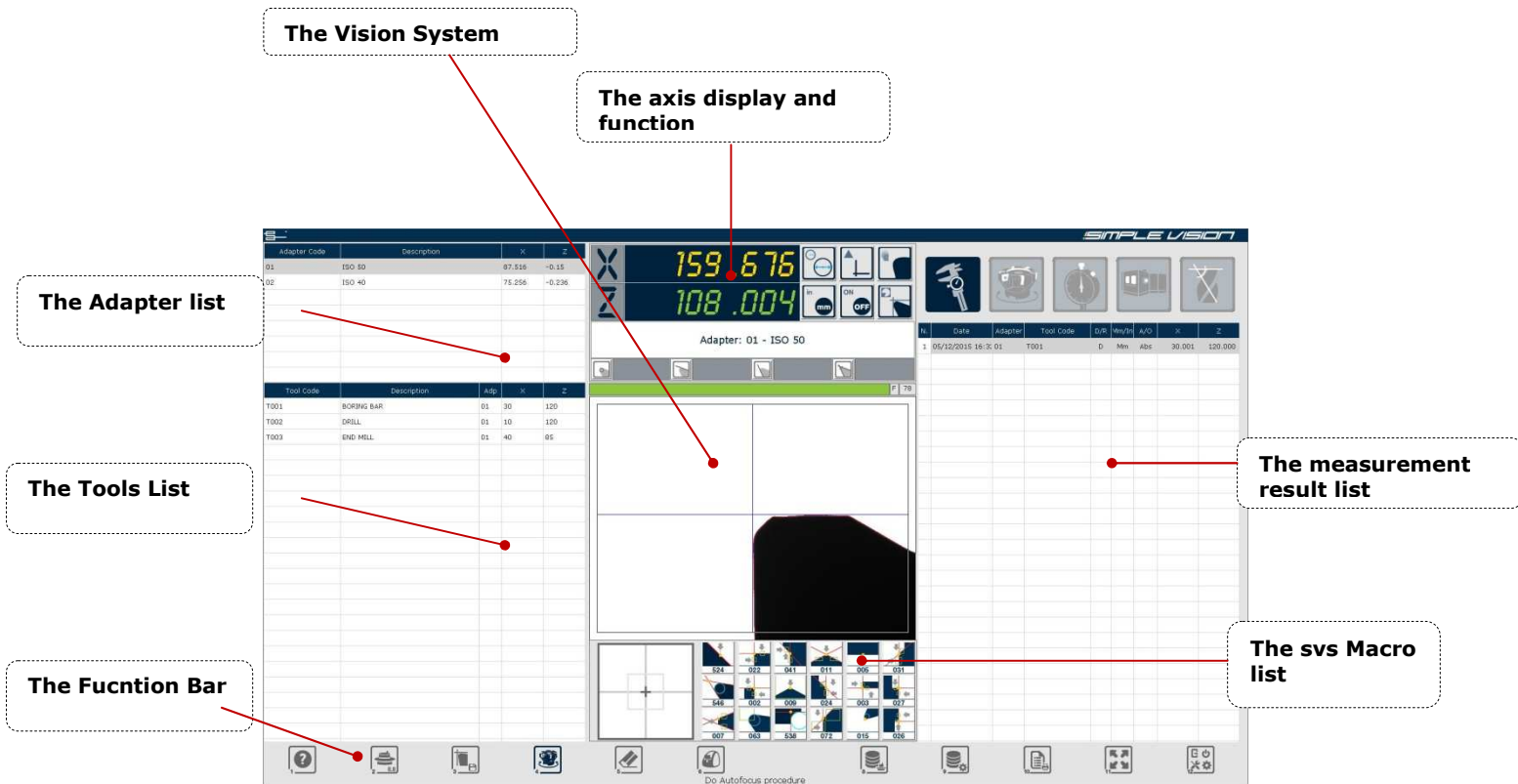

The function bar

The function bar it is represented by a series of button / function which are:

Help



This button shows the help window.

Reset Adapter



This button is used for the **Adapter Calibration**



When the push the button appears a confirm request:

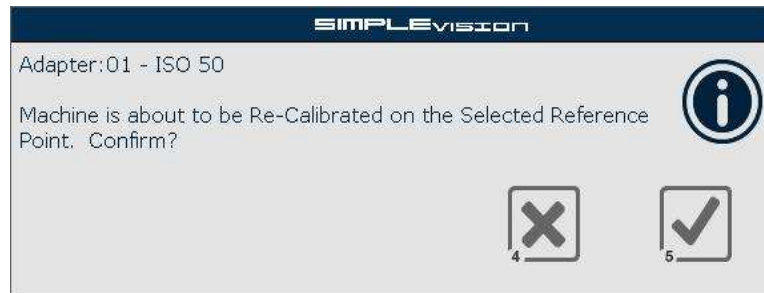

To confirm Adapter Calibration push **confirm**



Else push **Cancel**



If Adapter selection for the reset is referred to another Adapter (See "Data Adapter" chapter) the message will display also the codes of related Adapters. For example:



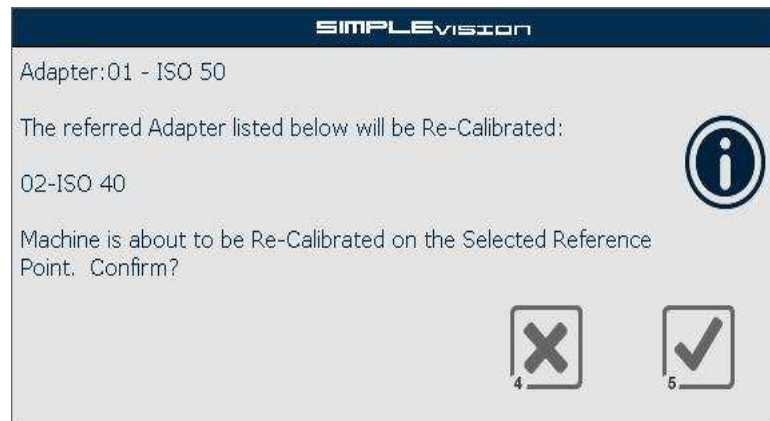

Memo quote



This button allows you to **Save** the actual value of Axis and insert the data in Measurement result list.

Print Measurement List





This button allows you to **Print** the actual values in the Measurements results list.

If it's present only the Labels Printer, after having selected the row or more rows from the list you want to print, appears a window that shows you the rows that will be printed.

In the example window below we are printing **from** row 2 **to** row 2 (only the row number 2).

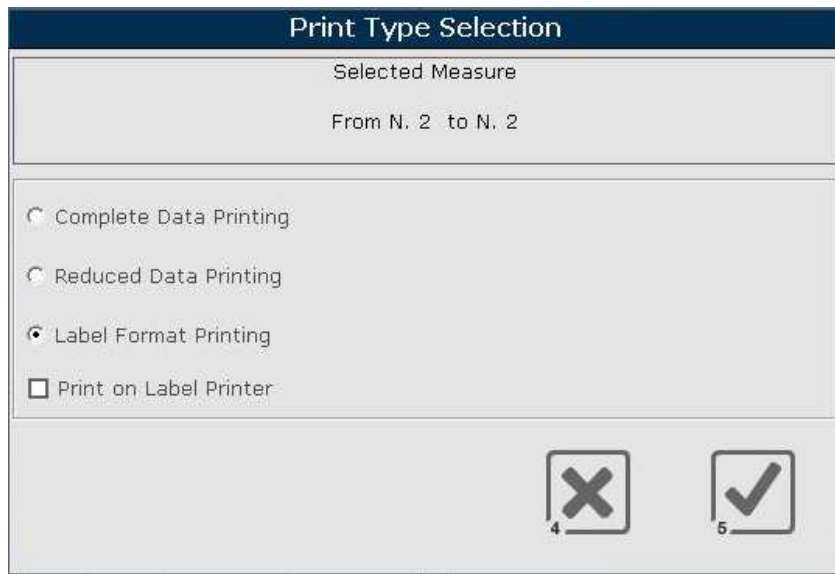



To confirmation push **Confirm** 

To cancel push **Cancel** 

It's possible to select the 0type of print among:



Complete print of data

Reduced print of datai

Labels Print of selected data with the possibility to select directly the print on the Labels Printer

Complete print layout



Measurement Results List

N.	Date	Adapter	Tool Code				X	Z	Radius	A1	A2	A3
1	10/14/2008 11.44	01	T001	D	Mm	Abs	359.618	326.895	0.825	0.20	80.02	79.82
2	10/14/2008 11.45	01	T001	D	Mm	Off	0.538	0.642	0.825	0.20	80.02	79.82
3	10/14/2008 11.48	01	T002	D	Mm	Abs	16.018	149.995	0.825	0.20	80.02	79.82

Reduced print layout

Measurement Results List

N.					X	Z
1	T001	D	Mm	Abs	359.618	326.895
2	T001	D	Mm	Off	0.538	0.642
3	T002	D	Mm	Abs	16.018	149.995

Labels print layout

```

Speroni SIMPLEvision
Tool_:T001      Adp__:01
Descr:BORING BAR
X_:359.618    <Mm><D><A>
Z_:326.895    <Mm><A>
R_:0.825     A1:0.20
A2_:80.02    IA:79.82
Date_:10/14/2008 11.44

Speroni SIMPLEvision
Tool_:T001      Adp__:01
Descr:BORING BAR
X_:0.538      <Mm><D><I>
Z_:0.642      <Mm><I>
R_:0.825     A1:0.20
A2_:80.02    IA:79.82
Date_:10/14/2008 11.45

Speroni SIMPLEvision
Tool_:T002      Adp__:01
Descr:DRILL
X_:16.018     <Mm><D><A>
Z_:149.995    <Mm><A>
R_:0.825     A1:0.20
A2_:80.02    IA:79.82
Date_:10/14/2008 11.48

```



Cancel measurement result list



This button allows you to **Delete** the measurement result list.

It appears a window that shows you the rows that will be deleted.

In the example window below we are deleting **from** row 3 **to** row 3 (only the row number 3).

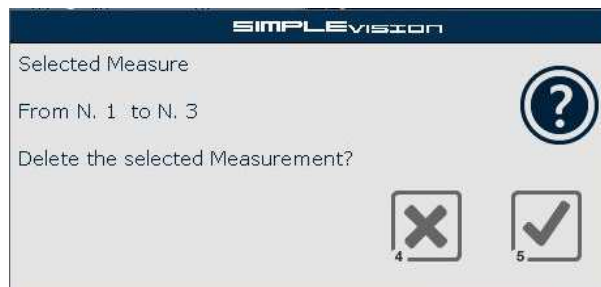

To confirm push **Confirm**



To cancel push **Cancel**



Print Label



This button allows you to **Print a Label** reporting the values currently active on screen.

Macro SVS Configuration





This button allows you to open the Questo pulsante permette di aprire la finestra delle **Macro SVS.Configuration Window** .

Adapter management



This button opens **The Adapter Management** window See "The Adapter Management window".

Tools management



This button opens **The Tools Management** window See "The Tools Management window".

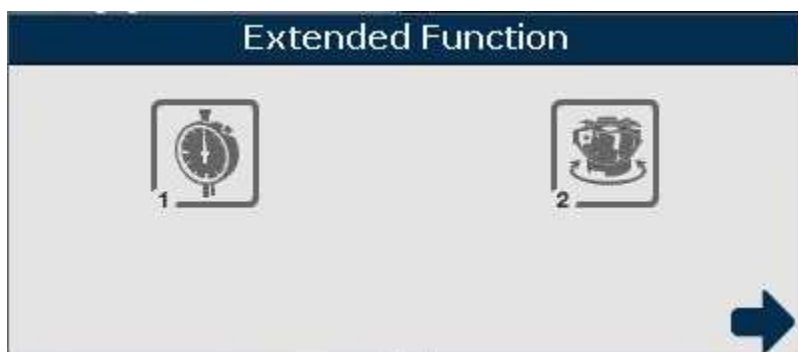

Image will be displayed full screen SVS.

RunOut Function



This button opens the window from which to choose the **RunOut Function**.



This button opens the window of the **Runout** function in **Dial Gauge** mode. See " Dial Gauge function window"



This button opens the **Runout** measurement window in the **Vision Sistem data release** mode. See " Runout function window"



PostProcessor



This button opens the "Post processor" management window. See " Postprocessor management window

Utilities Function



This button opens the window from which choose the **Utilities Function**.



This button opens the Save window (Backup) and the Restore window (Restore) of the data and system configuration. See " backup and restore Function"



This button opens the window for configuring the Parameters of the System (Options). See " Options Window"



This button allows to set the angle measurement in **Standard** or **Normal** mode (as a 90° complement as opposed to Standard)



This button switches from decimal degrees to sexsagesimal.



This button activates the Binary function which allows to value the light close to the Tool's profile. In the vision system window can be seen



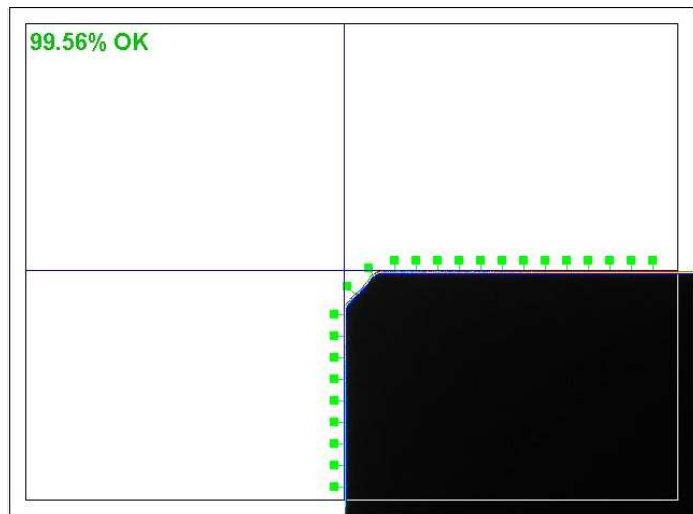

- a) The tool's profile in colour
- b) Profile marker of the vision quality with the following colours:

Light Green: Optimal

Dark green: Within Tolerance

Yellow: In the edge of tolerance

Red: Out of tolerance



Grey: Out of focus. It can not be measured.

When this function is activated, the deactivate button will be Disabled





This button enables the function of Remote Support that allows remote support allowing operators Speroni to connect to the computer of the machine via an internet connection.

Remote support	
The Remote Support is running correctly. Wait until your request will be activated...	
Remote Support information	
Customer:	CUSTOMER NAME
STP Serial Number:	0006682
Remote Support ID	1 051 893 164
<div style="display: flex; justify-content: space-around; align-items: center;"> <div style="text-align: center;">  <p>2</p> </div> <div style="text-align: center;">  <p>4</p> </div> <div style="text-align: center;">  <p>5</p> </div> <div style="text-align: center;">  <p>6</p> </div> </div>	



Make the connection to allow remote support. It also sends an e-mail to the operators Speroni to request assistance.



Closes the dialog remote support and return to the previous.



It lets get the Machine Data (in particular the unique ID code) required to connect the remote support.

Once you push the "Connect" button F2 the function bar will present the following icons



Close the connection remote support.



Support Information



Show the window with the connection information to the remote support.

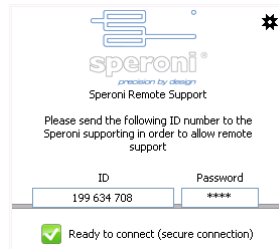

Through this window you have the ability to check the status of the connection and, if necessary, set certain parameters for the correct connection. To close this window, push the **"Hide information"**.



Once connected the remote support contact technical Speroni.



This button is used to store a .jpg file of printing full page acquired by pressing the Print / Print Screen Keyboard. You will see the following dialog box that allows the selection of the destination and the destination folder:



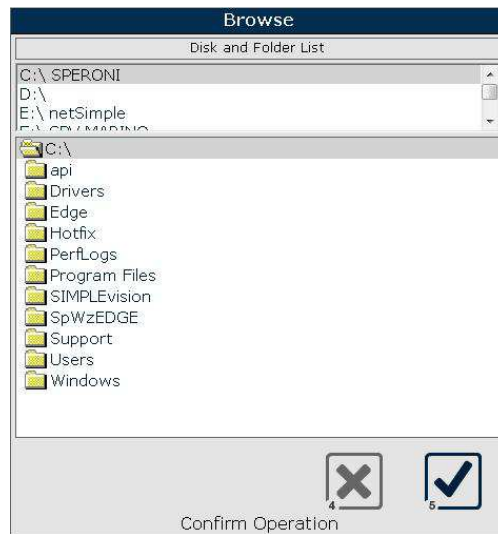

Pressing F5 Confirm the ScreenShot icon you will be stored on the disk / folder.

The image is in BMP

The file name will be generated automatically dal SW MAGIS :
MAGIS_SCREENyyyyymmddhhmm.bmp

yyyy = year
mm = month
dd = day
hh : hour
mm minuts





This button allows storing a .bmp file of the image currently displayed by the camera.

You will see the following dialog box that allows the selection of the destination and the destination folder:

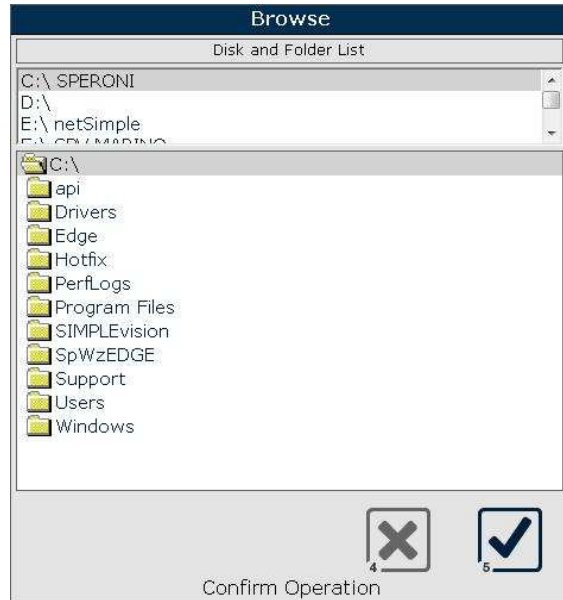

Pressing F5 Confirm the ScreenShot icon you will be stored on the disk / folder.

The image is in BMP
The file name will be generated automatically Sw MAGIS :
MAGIS_SVSIMAGEyyyyymmddhhmm.bmp
yyyy = year
mm = month
dd = day
hh : hour
mm minuts
Example save image:





This button allows to finalize the application and shut down the machine. A confirmation window will show up:



To confirmation push **Confirm**



To cancel push **Cancel**



The Adapter list

Adapter Code	Description	X	Z	
01	ISO 50	87.516	-0.15	
02	ISO 40	75.256	-0.236	
Tool Code	Description	Adp	X	Z

In the adapter list there are the adapter presents in the database. The grid is composed by:

- **Adapter Code:** the code of adapter;
- **Description:** the description of adapter;



- **X**: the adapter X gage;
- **Z**: the adapter Z gage;

To select an adapter click on it. It appears a little green "Pin"



that show the selected adapter.

When you select an adapter, in the Tools list are showed the tools associate to selected adapter.

If there is only one adapter, this will be automatically selected.

The tools list

Tool Code	Description	Adp	X	Z				
T001	BORING BAR	01	30	120				
T002	DRILL	01	10	120				
T003	END MILL	01	40	85				
N.	Date	Adapter	Tool Code	D/R	Mm/In	A/O	X	Z

In the tools list there are the tools presents in database, associated to selected adapter. The grid is composed by:

- **Tools code**: the code of tool;
- **Description**: the description of tool;
- **Adp**: the adapter code associated to the tools;
- **X**: the tool X gage;
- **Z**: the tool X gage.

To select a tool click on it. It appears a little green "Pin"



that show the selected tool.

To deselect the tool click on an empty row.



The measurement result list

N.	Date	Adapter	Tool Code	D/R	Mm/In	A/O	X	Z
1	05/12/2015 16:29	01	T003	D	Mm	Abs	40.000	85.000
2	05/12/2015 16:30	01	T002	D	Mm	Abs	10.001	120.000
3	05/12/2015 16:30	01	T001	D	Mm	Abs	30.001	120.000

In the measurements results list there are the results of the carried out measurements. The grid is composed by:

- **N.** : the number of measurement. When you click on it you select **all** the list rows;
- **Data**: the day and the hour of the carried out measurement;
- **Adapter**: the code of used adapter;
- **Tool Code**: the code of used tool;
- **D/R**: it specify if the measurement it's carried out by **Diameter gage** or **Radius gage**;
- **Mm/In**: it specify the measure unit (**Millimeters** or **Inches**) of the measurement carried out;
- **A/O**: it specify the type of measure (**Absolute** or **Offset**);
- **X** e **Z**: the captured gage.

It's possible to view the measurements of radius and angles you have made by clicking on the row of the measure.



N.	Date	Adapter	Tool Code	D/R	Mm/In	A/O	X	Z
1	05/12/2015 16:29:01	01	T003	D	Mm	Abs	40.000	85.000
2	05/12/2015 16:30:01	01	T002	D	Mm	Abs	10.001	120.000
3	05/12/2015 16:30:01	01	T001	D	Mm	Abs	30.001	120.000
				Radius		A1	A2	A3

To **delete** one or more rows of the list, select the rows what you want to delete and push



Delete Measurements Results

To **print** one or more rows of the list, select the rows what you want to print and push



Print Measurements Results

To select ALL THE DATA, click on the title of the grid that identify the number of measurement **"N."**

The operative modes and the choice among the possible Press Layout are present in the section previously described.



The display axis and it's functions

The display axis visualizes the machine axis position or the measure that you are using, differently that you are using **Diameter** or **Radius**, **Absolute** or **Relative**.

If you select a tool, appears the function of Real/Offset visualization later described.



The display axis shows:



The X axis label (Horizontal)

It can change from "D" or "R" depending on the setting (**Diameter** or **Radius**). If you have deselected the parameter "Visualize D or R in the X dimension" the label will be "X".



The Z axis label (vertical).

It can change from "Z" or "X" depending on the setting.



The gage of axis.

The color can change; for each color there is a different meaning:

- GREEN: axis ok;
- WHITE: offset enable;
- YELLOW: measure out of tolerance;
- ROSE: axis not zeroed;
- RED: axis in error;
- BLUE: axis in zeroing;
- CYAN: axis frozen.



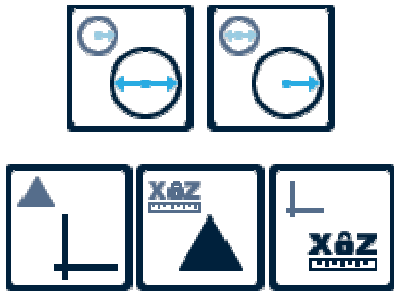

Diameter / Radius.

It sets the measure unit to Diameter or Radius.

Funzione di Azzeramento quote.



With the function  (Absolute) the values displayed in the respective quote are the absolute quote respect to the selected Adapter or the selected tool.



With the function  (Zeroing) you can set up zero on a given axis to make measures of distance. To reset a given axis click you on the relative word. The selected axis quote will be set on "**0.000**" and the colour will become **WHITE**.



With the function  (Lock XZ) you can fix the present value measured on an axis and make a measure on the other axis in a different position. To block a particular axis click you on the relative word. It will then be possible to set an Offset with respect to the current measure.



Offset

Insert the 'Offset' to apply:

0

✕
4

✓
5

Set the desired Offset and confirm  or cancel 

The measure is turned on automatically..



Absolute / Offset

It sets the gage visualization to Absolute (measures reported to adapter) or Offset (measure reported to theoretical gage).

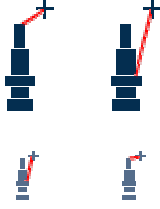



Millimeters / Inches

It sets the measure units to Millimeters or Inches.



Freeze gage ON / OFF

Enable or Disable the freeze gage function.
If you want to freeze an axis click on its label.

The selected axis color becomes **CYAN**.

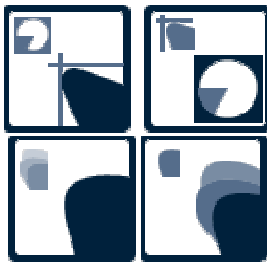

Automeasure / Digital Projector

It sets the measure modality of Vision System on Automeasure (to calculate the maximum diameter and the maximum height of tool) or Digital Projector.

Maximum profile ON / OFF

Enable or disable the maximum profile function.
The MaxP function allows to store, as SVS image of measure, the resultant image of the highest profile in rotation of the tool. In practice it generates a profile of the "Solid of Revolution" generated from the tool.
When the function is enabled, appears in "Black" the maximum resulting profile on which will be applied the measures and in "Grey" the currently acquired image.

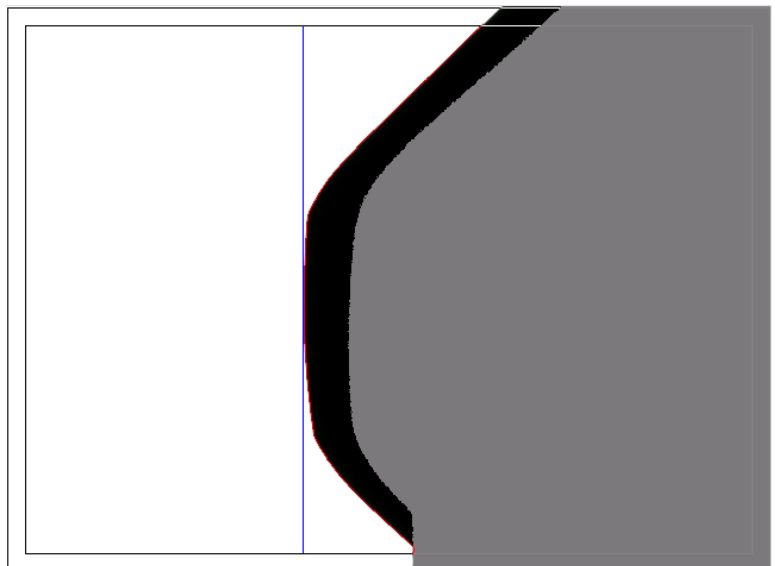

Adapter: 01	ISO 50
Tool: T001	BORING BAR
Cutter: 0001	

The selected adapter and the selected tool

It shows you the selected adapter and the selected tool.

No Adapter selected...

If no adapter is selected appears the writing "No adapter selected".



Enable / Disable "Radius" measur

It measures the radius of tool.
It's active on Automeasure function.



Enable / Disable "Top angle" measur

It measures the top angle of tool.
It's active on Automeasure function.



Enable / Disable "Bottom angle" measur

It measures the bottom angle of tool.
It's active on Automeasure function.



Enable / Disable "Both angle" measur

It measures the both angle of tool.
It's active on Automeasure function.



The Vision System and the Focus Bar

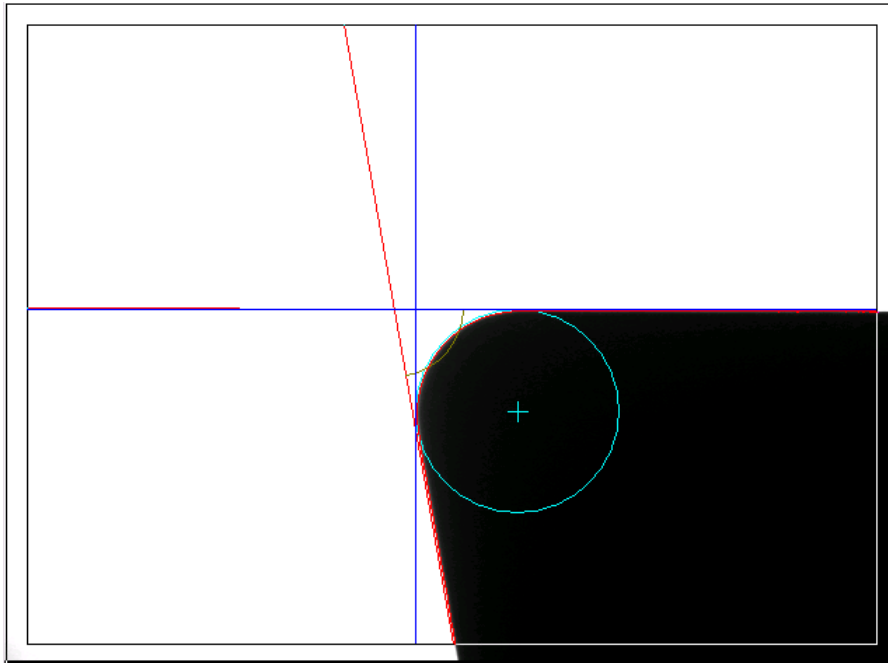

The Vision System show you the image framed by television camera.

Before any measurement **it** is necessary to put the tool in the correct position. To do this, on the top the Vision System window there is the **Focus bar**. If the Focus bar is **GREEN** the tool is in the correct posizione. If, instead, the Focus bar is **BLU** or **RED**, rotate the tool up to reach the green.

The Vision System window can present in two ways:

- Digital Projector;
- Automeasure.

To enable the "Digital Projector" function is necessary to disable the "Automeasure" function pushing the button



The Vision System will become in this way

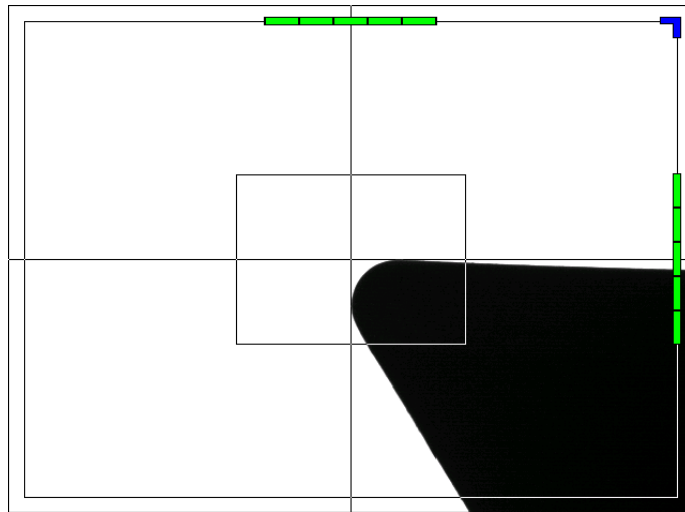

In this window you can see:

- The horizontal position indicators;
- The vertical position indicators;
- The central position indicator;

The Z axis position indicators:

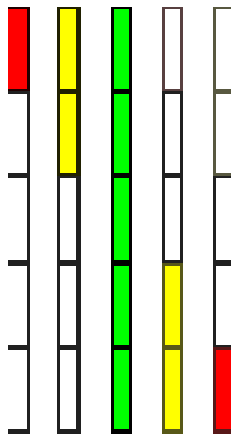

help the operator to coincide the Vision System image with the horizontal axis moving the Z axis.

The X axis position indicators:



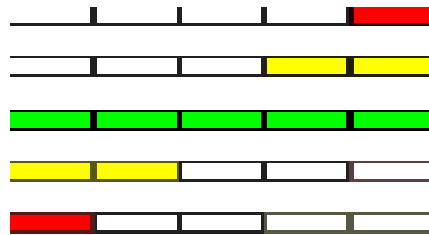

help the operator to coincide the Vision System image with the vertical axis moving the X axis. These indicators can assume the colors:

- Green: the image is in coincidence;
- Yellow: if the image is distant enter far 10 micron from coincidence;
- Red: if the image is distant enter far 30 micron from coincidence.

The position indicators, besides, show the part in which the image is exceeding drawing itself above or under (for the Z axis indicators), right or left (for the X axis indicators).

The central position indicator



is used to coincide the Vision System image with the center of window. If the color is BLUE, the image don't covers the center. If the color is RED the image covers the center. If the color is GREEN the image is in coincidence whit the center.

Placing the mouse cursor on the SVS window for at least 1 second, appear the function of Zoom

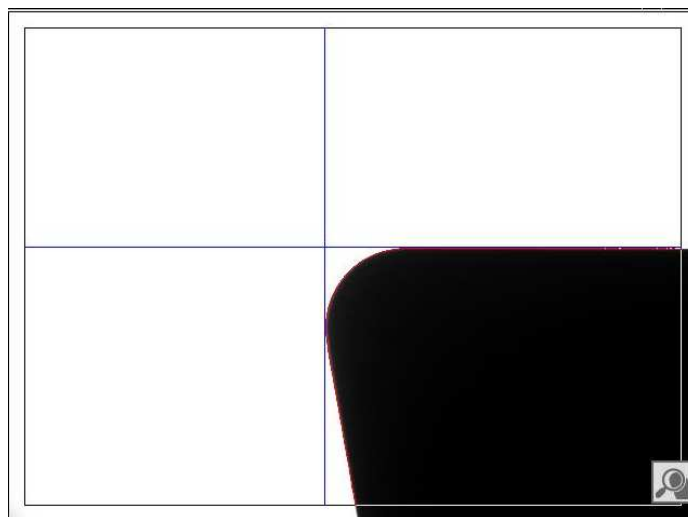

Step from Zoom 1x 2x and 3x of Standard

It makes the transition from Virtual zoom of the image displayed from 1x to 2x and



3x of the standard display.

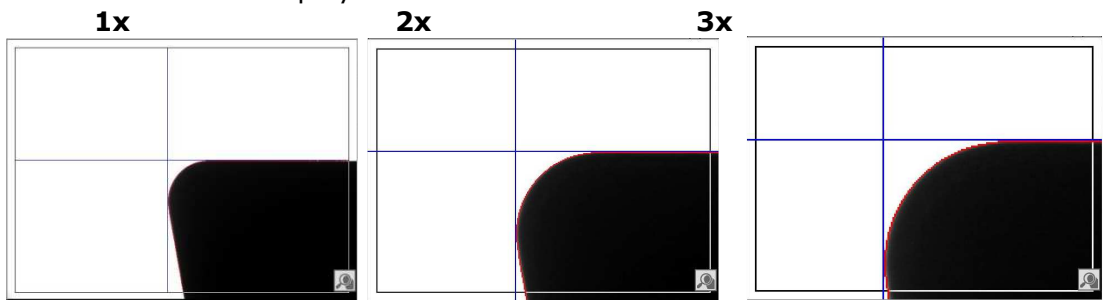

**Full-screen display of the SVS**

Enables full-screen display of SVS image

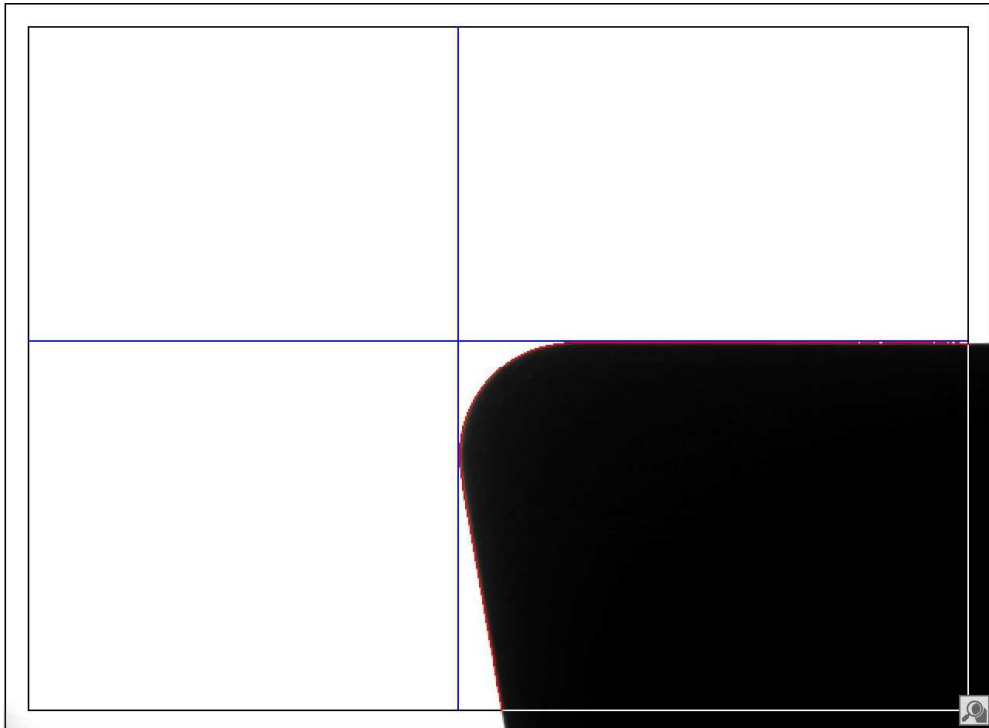

Also in full-screen mode is available the Zoom function 1x, 2x and 3x



To return to standard display mode use you the function



The SVS measure Complete List

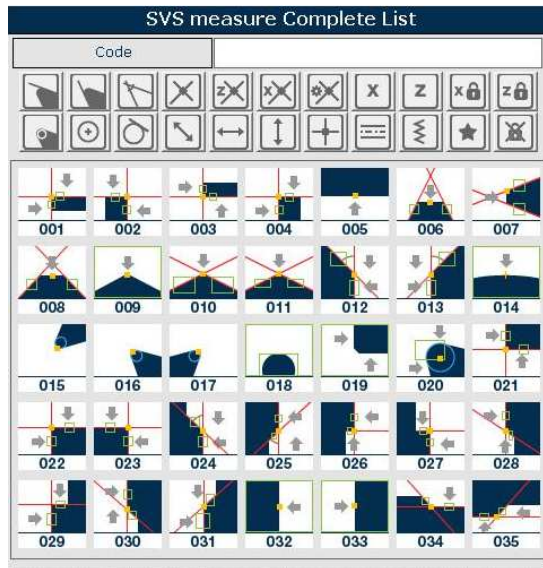

The SvsMacro list show you the available SvsMacro.

A SvsMacro is a special measure that can be used on a tool that have a special caratteristics.

Menu Macro S.V.S



By clicking on the menu button Macro SVS will appear next to the vision system instead of the grid measurement results a list of Macro.



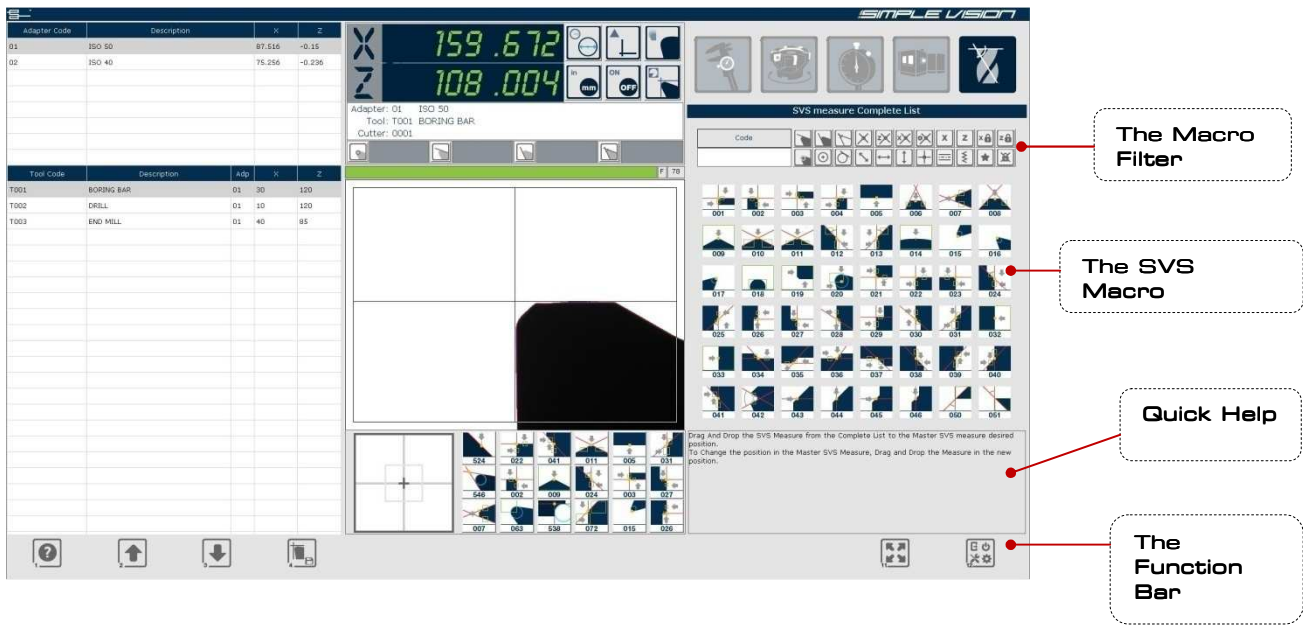

Clicking on a macro, the Vision System will activate the requested measure, that will showed, zoomed, on the left of SvsMacro list. Clicking on the zoomed image you can turn off the macro.



If the measure don't work correctly, the Vision System will show a red contour.

To modify the measure areas click on the interested area and, with the button that will appears, move or resize the area.

This functionality is also available clicking on the Vision System window when the macro work correctly.



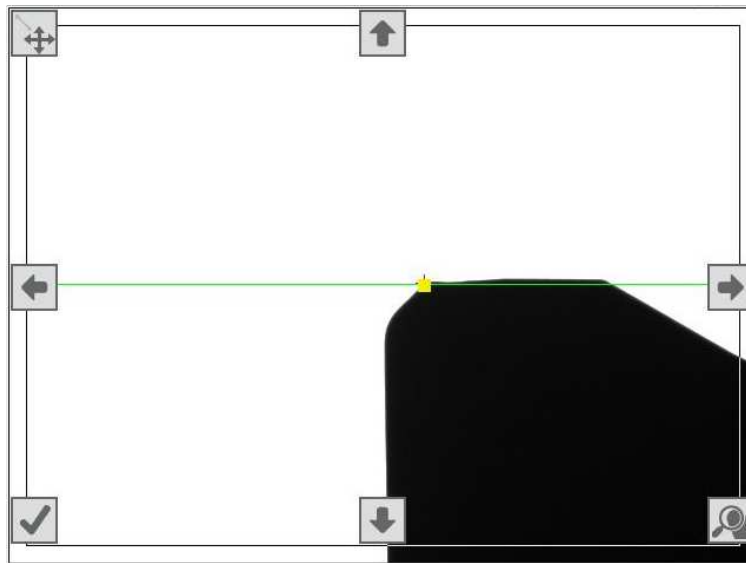

The selected area to modify will be drawn with yellow

The button for the change are:



Move / Resize

It allows you to swith from the "Move Area" function to "Resize Area" function and vice versa.



Right

If the "Move Area" function is selected, this button move the area to the right.

If the "Resize Area" is selected, this button increase the area width.



Left

If the "Move Area" function is selected, this button move the area to the left.

If the "Resize Area" is selected, this button decrease the area width.



Up

If the "Move Area" function is selected, this button move the area above.

If the "Resize Area" is selected, this button decrease the area height.



Down

If the "Move Area" function is selected, this button move the area under.

If the "Resize Area" is selected, this button increase the area height.



Confirm

To confirm the changes and hide the measure areas.

THIS BUTTON DON'T SAVE THE CHANGES (the changes are temporary).



The repositioning or re-dimensioning of the measurement areas can be carried out also using the mouse holding the left button and shifting it towards the desired direction.

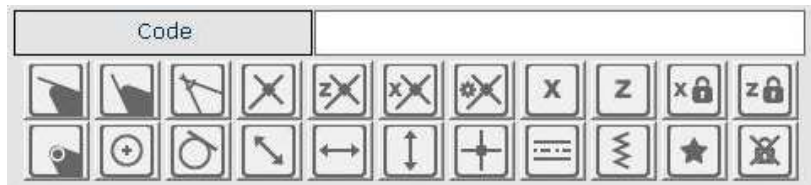

THE MACRO MEASURE SVS FILTER

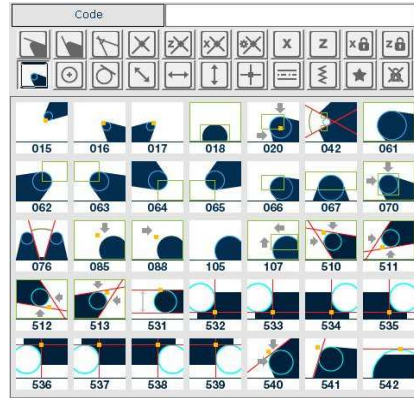

Using the filter can filter through all Macro going to choose the type of Macro concerned.

Selecting the type of interest such as  (Radius) will appear in category Macro Radius (see image).



also chain multiple Macro such as  radius and angle higher  Macro will appear in two categories selected (see image).

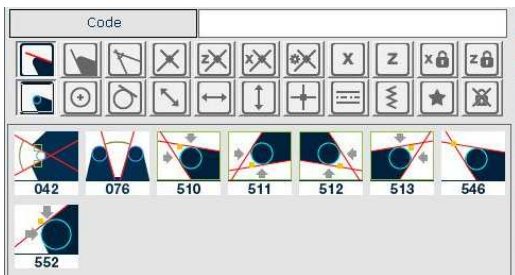

The Function Bar

The navigation menù show some images:

Help



This button allows open the help window.

Scroll Up



This button show you the **Previous** SvSMacro icons.

Scroll Down





This button show you the **Next** SvSMacro icons.

Confirm changes



This button allow to **Confirm** the changes on the SvSMacro list.

The SvSMacro list visible in the Main window and the SvSMacro complete list
The SvSMacro list visible in the main window can be modify dragging the SvSMacro icons from a place to another.

During the icon dragging in this list, the mouse cursor change like this shape:







Besides you can modify the SvSMacro list visible in the main window dragging above the icon that you want to change the new icon present in the complete list.

The mouse cursor change like this shape:



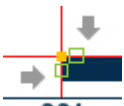
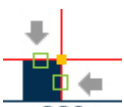
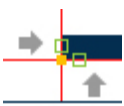
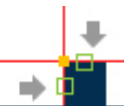







Macro SVS Icons

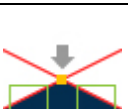







Below, a list of standard icons on your new system SIMPLVision Speroni.

 <p>001</p>	<p>001: Measurement of the Diameter (X Value) and the Height (Z Value) measured at the tangent point between the two lines as indicated by the arrows.</p> <p>The two lines have to be inside the highlighted areas.</p>
 <p>002</p>	<p>002: Measurement of the Diameter (X Value) and the Height (Z Value) measured at the tangent point between the two lines as indicated by the arrows</p> <p>The two lines have to be inside the highlighted areas.</p>
 <p>003</p>	<p>003: Measurement of the Diameter (X Value) and the Height (Z Value) measured at the tangent point between the two lines as indicated by the arrows.</p> <p>The two lines have to be inside the highlighted areas.</p>
 <p>004</p>	<p>004: Measurement of the Diameter (X Value) and the Height (Z Value) measured at the tangent point between the two lines as indicated by the arrows.</p> <p>The two lines have to be inside the highlighted areas.</p>
 <p>005</p>	<p>Measurement of the Height (Z Value) as indicated by the arrow.</p>
 <p>006</p>	<p>006: Measurement of the Height (Z Value) as indicated by the arrow.</p> <p>Measurement of the two Top Angles. The Angles have to be inside the highlighted areas.</p>
 <p>007</p>	<p>007: Measurement of the Diameter (X Value) as indicated by the arrow.</p> <p>Measurement of the two Angles. The Angles have to be inside the highlighted areas.</p>





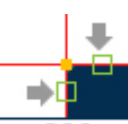
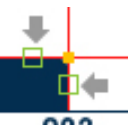





 <p>008</p>	<p>008: Measurement of the Height (Z Value) as indicated by the arrow.</p> <p>Measurement of the two Top Angles. The Angles have to be inside the highlighted areas</p>
 <p>009</p>	<p>009: Measurement of the maximum Height (Z Value) as indicated by the arrow.</p>
 <p>010</p>	<p>010: Measurement of the Height (Z Value) at the intersection of the two angles as indicated by the arrows.</p> <p>Measurement of the two Top Angles. The Angles have to be inside the highlighted areas</p>
 <p>011</p>	<p>011: Measurement of the Height (Z Value) at the intersection of the two angles as indicated by the arrows.</p> <p>Measurement of the two Top Angles. The Angles have to be inside the highlighted areas.</p>
 <p>012</p>	<p>012: Measurement of the Diameter (X Value) and the Height (Z Value) at the intersection of the two angles as indicated by the arrow.</p> <p>Measurement of the side Angles. The Angle has to be inside the highlighted area.</p>
 <p>013</p>	<p>013: Measurement of the Diameter (X Value) and the Height (Z Value) at the intersection of the two angles as indicated by the arrow.</p> <p>Measurement of the side Angles. The Angle has to be inside the highlighted area.</p>
 <p>014</p>	<p>014: Measurement of the maximum Height (Z Value).</p>
 <p>015</p>	<p>015: Measurement of the maximum Diameter (X Value) and the maximum Height (Z Value).</p> <p>Measurement of the Insert's nose Radius.</p>



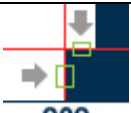







 <p>016</p>	<p>016: Measurement of the maximum Diameter (X Value) and the maximum Height (Z Value).</p> <p>Measurement of the Insert's nose Radius.</p>
 <p>017</p>	<p>017: Measurement of the maximum Diameter (X Value) and the maximum Height (Z Value).</p> <p>Measurement of the Insert's nose Radius.</p>
 <p>018</p>	<p>018: Measurement of the maximum Height (Z Value).</p> <p>Measurement of the Insert's nose Radius.</p>
 <p>019</p>	<p>019: Measurement of the maximum Diameter (X Value) and the maximum Height (Z Value) as indicated by the arrows.</p>
 <p>020</p>	<p>020: Insert's nose radius measurement.</p> <p>Measurement of the position of the radius center. The radius to be measured has to be inside the highlighted area.</p> <p>(This Icon is fixed - ROI don't follow image)</p>
 <p>021</p>	<p>021: Measurement of the Diameter (X Value) and the Height (Z Value) as indicated by the arrows.</p>
 <p>022</p>	<p>022: Measurement of the Diameter (X Value) and the Height (Z Value) measured at the tangent point between the two lines as indicated by the arrows.</p> <p>The two lines have to be inside the highlighted areas</p>
 <p>023</p>	<p>023: Measurement of the Diameter (X Value) and the Height (Z Value) measured at the tangent point between the two lines as indicated by the arrows.</p> <p>The two lines have to be inside the highlighted areas</p>
 <p>024</p>	<p>024: Measurement of the Diameter (X Value) and the Height (Z Value) at the intersection of the two angles as indicated by the arrow. Measurement of the side Angles. The Angle has to be inside the highlighted area</p>









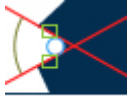

 <p>025</p>	<p>025: Measurement of the Diameter (X Value) and the Height (Z Value) at the intersection of the two angles as indicated by the arrow.</p> <p>Measurement of the side Angles. The Angle has to be inside the highlighted area.</p>
 <p>026</p>	<p>026: Measurement of the Diameter (X Value) and the Height (Z Value) at the intersection of the step as indicated by the arrows</p>
 <p>027</p>	<p>027: Measurement of the Diameter (X Value) and the Height (Z Value) at the intersection of the step as indicated by the arrows.</p>
 <p>028</p>	<p>028: Measurement of the Diameter (X Value) and the Height (Z Value) at the intersection of the step as indicated by the arrows.</p>
 <p>029</p>	<p>029: Measurement of the Diameter (X Value) and the Height (Z Value) at the intersection of the step as indicated by the arrows.</p>
 <p>030</p>	<p>030: Measurement of the Diameter (X Value) and the Height (Z Value) at the intersection of the two angles as indicated by the arrow.</p> <p>Measurement of the side Angles. The Angle has to be inside the highlighted area..</p>
 <p>031</p>	<p>31: Measurement of the Diameter (X Value) and the Height (Z Value) at the intersection of the two angles as indicated by the arrow.</p> <p>Measurement of the side Angles. The Angle has to be inside the highlighted area..</p>
 <p>032</p>	<p>032: Measurement of the maximum Diameter (X Value) at a nominal Height (Z Value).</p>
 <p>033</p>	<p>033: Measurement of the maximum Diameter (X Value) at a nominal Height (Z Value).</p>











	<p>034: Measurement of the Height (Z Value) at the intersection of the two angles as indicated by the arrow.</p> <p>Measurement of the side Angles. The Angle has to be inside the highlighted area.</p>
	<p>035: Measurement of the Diameter (X Value) and the Height (Z Value) at the intersection of the two angles as indicated by the arrow.</p> <p>Measurement of the side Angles. The Angle has to be inside the highlighted area.</p>
	<p>036: Measurement of the Diameter (X Value) and the Height (Z Value) at the intersection of the two angles as indicated by the arrow.</p> <p>Measurement of the side Angles. The Angle has to be inside the highlighted area.</p>
	<p>037: Measurement of the Diameter (X Value) and the Height (Z Value) at the intersection of the two angles as indicated by the arrow..</p> <p>Measurement of the side Angles. The Angle has to be inside the highlighted area.</p>
	<p>038: Measurement of the Diameter (X Value) and the Height (Z Value) at the intersection of the two angles as indicated by the arrow.</p> <p>Measurement of the side Angles. The Angle has to be inside the highlighted area..</p>
	<p>039: Measurement of the Diameter (X Value) and the Height (Z Value) at the intersection of the two angles as indicated by the arrow..</p> <p>Measurement of the side Angles. The Angle has to be inside the highlighted area..</p>
	<p>040: Measurement of the Diameter (X Value) and the Height (Z Value) at the intersection of the two angles as indicated by the arrow.</p> <p>Misura degli angoli laterali. L'angolo deve trovarsi all'interno dell'area evidenziata.</p>
	<p>041: Measurement of the Diameter (X Value) and the Height (Z Value) at the intersection of the two angles as indicated by the arrow. Measurement of the side Angles. The Angle has to be inside the highlighted area.</p>

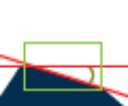

 <p>042</p>	042: Measurement of the two Angles as shown in the highlighted areas.
 <p>043</p>	043: Measurement of the Diameter (X Value) at a nominal Height (Z Value).
 <p>044</p>	044: Measurement of the Height (Z Value) at a nominal Diameter (X Value).
 <p>045</p>	045: Measurement of the Diameter (X Value) at a nominal Height (Z Value).
 <p>046</p>	046: Measurement of the Height (Z Value) at a nominal Diameter (X Value).
 <p>050</p>	050: Angle Measurement. The angle to be measured has to be inside the highlighted area. (This Icon is fixed - ROI don't follow image)
 <p>051</p>	051: Angle Measurement. The angle to be measured has to be inside the highlighted area. (This Icon is fixed - ROI don't follow image)
 <p>052</p>	052: Angle Measurement. The angle to be measured has to be inside the highlighted area. (This Icon is fixed - ROI don't follow image)
 <p>053</p>	053: Angle Measurement. The angle to be measured has to be inside the highlighted area. (This Icon is fixed - ROI don't follow image)











 <p>054</p>	<p>054: Measurement of the Angle included between the two lines measured inside the highlighted areas.</p> <p>(This Icon is fixed - ROI don't follow image)</p>
 <p>055</p>	<p>055: Measurement of the Angle included between the two lines measured inside the highlighted areas.</p> <p>(This Icon is fixed - ROI don't follow image)</p>
 <p>056</p>	<p>056: Angle Measurement.</p> <p>The angle to be measured has to be inside the highlighted area.</p> <p>(This Icon is fixed - ROI don't follow image)</p>
 <p>057</p>	<p>057: Measurement of the maximum Diameter (X Value) at a nominal Height (Z Value).</p>
 <p>058</p>	<p>058: Measurement of the maximum Diameter (X Value) at a nominal Height (Z Value).</p>
 <p>059</p>	<p>059: Measurement of the maximum Height (Z Value) at a nominal Diameter (X Value).</p>
 <p>060</p>	<p>060: Measurement of the maximum Height (Z Value) at a nominal Diameter (X Value).</p>
 <p>061</p>	<p>061: Radius Measurement.</p> <p>The radius to be measured has to be inside the highlighted area.</p> <p>(This Icon is fixed - ROI don't follow image)</p>
 <p>062</p>	<p>062: Radius Measurement</p> <p>The radius to be measured has to be inside the highlighted area.</p> <p>(This Icon is fixed - ROI don't follow image)</p>











 <p>063</p>	<p>063: Radius Measurement</p> <p>The radius to be measured has to be inside the highlighted area.</p> <p>(This Icon is fixed - ROI don't follow image)</p>
 <p>064</p>	<p>064: Radius Measurement</p> <p>The radius to be measured has to be inside the highlighted area.</p> <p>(This Icon is fixed - ROI don't follow image)</p>
 <p>065</p>	<p>065: Radius Measurement</p> <p>The radius to be measured has to be inside the highlighted area.</p> <p>(This Icon is fixed - ROI don't follow image)</p>
 <p>066</p>	<p>066: Radius Measurement</p> <p>The radius to be measured has to be inside the highlighted area.</p> <p>(This Icon is fixed - ROI don't follow image)</p>
 <p>067</p>	<p>067: Radius Measurement</p> <p>The radius to be measured has to be inside the highlighted area.</p> <p>(This Icon is fixed - ROI don't follow image)</p>
 <p>070</p>	<p>070: Measurement of the maximum Diameter (X Value) and the maximum Height (Z Value).</p> <p>This icon also measures the nose radius.</p>
 <p>071</p>	<p>071: Measurement of the maximum Diameter (X Value) and the maximum Height (Z Value).</p>
 <p>072</p>	<p>072: Measurement of the Diameter (X Value) and the Height (Z Value) measured at the intersection between the two lines measured in the two highlighted areas.(This Icon is fixed - ROI don't follow image)</p>
 <p>073</p>	<p>073: Measurement of the Diameter (X Value) and the Height (Z Value) at the tangent point between the measured line and the measured radius.</p>











 <p>074</p>	<p>074: Measurement of the Diameter (X Value) and the Height (Z Value) measured at the intersection between the two measured lines.</p>
 <p>075</p>	<p>075: Measurement of the Diameter (X Value) and the Height (Z Value) measured at the intersection between the two measured lines.</p>
 <p>080</p>	<p>080: Measurement maximum Height (Z Value) as indicated by the arrow.</p>
 <p>081</p>	<p>081: Measurement of the maximum Diameter (X Value) and the maximum Height (Z Value) as indicated by the arrows.</p>
 <p>082</p>	<p>082: Measurement of the Height (Z Value) measured at the tangent point between the two lines as indicated by the arrows. The two lines have to be inside the highlighted areas. (This Icon is fixed - ROI don't follow image)</p>
 <p>083</p>	<p>083: Measurement of the Diameter (X Value) and the Height (Z Value) measured at the tangent point between the two lines as indicated by the arrows. The two lines have to be inside the highlighted areas. (This Icon is fixed - ROI don't follow image)</p>
 <p>084</p>	<p>084: Measurement maximum Height (Z Value) as indicated by the arrow.</p>
 <p>085</p>	<p>085: Measurement maximum Height (Z Value) and the Radius as indicated by the arrow. The Radius' form error is also measured.</p>











 <p>086</p>	<p>086: Measurement maximum Height (Z Value) as indicated by the arrow.</p>
 <p>087</p>	<p>087: Measurement of the Angle included in the two lines. Also measured are the Diameter (X Value) and the Height (Z Value) as indicated by the arrow. The two lines have to be inside the highlighted areas. (This Icon is fixed - ROI don't follow image)</p>
 <p>088</p>	<p>088: Measurement maximum Diameter (X Value) and the Radius as indicated by the arrow. The Radius' form error is also measured.</p>
 <p>089</p>	<p>089: Measurement of the Distance between the Height (Z Value) of the upper blade and the Height (Z Value) of the lower blade as indicated by the arrows.</p>
 <p>090</p>	<p>090: Measurement of the Distance between the Height (Z Value) of the upper blade and the Height (Z Value) of the lower blade as indicated by the arrows. Also Measured is the Maximum Diameter (X Value) as indicated by the arrow.</p>
 <p>091</p>	<p>091: Measurement of the Maximum Diameter (X Value) as indicated by the arrow.</p>
 <p>092</p>	<p>092: Measurement of the Diameter (X Value) measured at the tangent point between the two lines as indicated by the arrows. The two lines have to be inside the highlighted areas. (This Icon is fixed - ROI don't follow image)</p>
 <p>093</p>	<p>093: Measurement of the Diameter (X Value) and the Height (Z Value) measured at the tangent point between the two lines as indicated by the arrows. The two lines have to be inside the highlighted areas. (This Icon is fixed - ROI don't follow image)</p>











 <p>094</p>	<p>094: Measurement of the Maximum Diameter (X Value) as indicated by the arrow.</p>
 <p>095</p>	<p>095: Measurement of the Maximum Diameter (X Value) as indicated by the arrow..</p>
 <p>096</p>	<p>096: Measurement of the Diameter (X Value) and the Height (Z Value) measured at the tangent point between the line and the radius.</p>
 <p>100</p>	<p>100: Measurement of the maximum Diameter (X Value) and the maximum Height (Z Value) as indicated by the arrows.</p>
 <p>101</p>	<p>101: Measurement of the maximum Diameter (X Value) as indicated by the arrow.</p>
 <p>102</p>	<p>102: Measurement of the maximum Height (Z Value) as indicated by the arrow.</p>
 <p>103</p>	<p>103: Measurement of the maximum Diameter (X Value) and the maximum Height (Z Value) as indicated by the arrows.</p>
 <p>104</p>	<p>104: Measurement of the Diameter (X Value) and the Height (Z Value) as indicated by the arrows.</p>
 <p>105</p>	<p>105: Measurement of the Radius. The Radius' form error is also measured.</p>











 <p>106</p>	<p>106: Measurement of the Diameter (X Value) and the Height (Z Value) as indicated by the arrows.</p>
 <p>107</p>	<p>107: Measurement of the Insert Radius. Measurement of the center coordinates of the radius expressed in Diameter (X Value) and Height (Z Value).</p>
 <p>109</p>	<p>109: Measurement of the Diameter (X Value) and the Height (Z Value) at the intersection of the two angles as indicated by the arrows.</p>
 <p>110</p>	<p>110: Measurement of the Diameter (X Value) and the Height (Z Value) at the intersection of the two angles as indicated by the arrows.</p>
 <p>111</p>	<p>111: Measurement of the maximum Diameter (X Value) and the maximum Height (Z Value).</p>
 <p>113</p>	<p>113: Measurement of the Diameter (X Value) and the Height (Z Value) at the intersection of the two lines. This icon also measures the Chamfer Angle.</p>
 <p>114</p>	<p>114: Measurement of the Diameter (X Value) and the Height (Z Value) at the intersection of the two lines. This icon also measures the Chamfer Angle.</p>
 <p>115</p>	<p>115: Measurement of the Diameter (X Value) and the Height (Z Value) at the intersection of the two lines. This icon also measures the Chamfer Angle.</p>
 <p>117</p>	<p>117: Measurement of the Diameter (X Value) and the Height (Z Value) at the intersection of the two lines. This icon also measures the Chamfer Angle.</p>



 <p>120</p>	<p>120: Measurement of the maximum Diameter (X Value).</p>
 <p>121</p>	<p>121: Measurement of the maximum Diameter (X Value).</p>
 <p>122</p>	<p>122: Measurement of the Included Angle between the two measured lines as indicated by the highlighted areas. (This Icon is fixed - ROI don't follow image)</p>
 <p>123</p>	<p>123: Measurement of the Diameter (X Value) and the Height (Z Value) measured at the tangent point between the line and the radius.</p>
 <p>126</p>	<p>126: Measurement of the maximum Diameter (X Value) and the maximum Height (Z Value).</p>
 <p>127</p>	<p>127: Measurement of the Diameter (X Value) and the Height (Z Value) of the two points as indicated by the arrows. Measurement of the Included Angle.</p>
 <p>128</p>	<p>128: Measurement of the Diameter (X Value) and the Height (Z Value) of the two points as indicated by the arrows. Measurement of the Included Angle.</p>
 <p>129</p>	<p>129: Measurement of the Diameter (X Value) and the Height (Z Value) at the intersection of the two lines as indicated by the arrows.</p>
 <p>130</p>	<p>130: Measurement of the Diameter (X Value) and the Height (Z Value) of the two points as indicated by the arrow. Measurement of the Included Angle between the two lines</p>



 <p>131</p>	<p>131: Measurement of the Diameter (X Value) and the Height (Z Value) as indicated by the arrow.</p> <p>Measurement of the Included Angle.</p>
 <p>136</p>	<p>136: Measurement of the maximum Diameter (X Value).</p>
 <p>137</p>	<p>137: Measurement of the maximum Height (Z Value).</p>
 <p>138</p>	<p>138: Measurement of the maximum Diameter (X Value) and the maximum Height (Z Value).</p>
 <p>148</p>	<p>148: Measurement of the Step as indicated by the arrows.</p>
 <p>149</p>	<p>149: Measurement of the Step as indicated by the arrows.</p>
 <p>150</p>	<p>150: Measurement of the Included Angle.</p>
 <p>153</p>	<p>153: Measurement of the Included Angle.</p>
 <p>154</p>	<p>154: Measurement of the Lead Angle.</p>



THE ADAPTER MANAGEMENT WINDOW

The screenshot shows the 'Adapter Management' window with the following fields and controls:

Adapter Code	01		
Description	ISO 50		
Measure Unit	Millimeters		
X Value	Diameter		
Ref. Adapter	No Adapter		
X	87.516	Z	-0.15
	<input type="checkbox"/> Mirror X	<input type="checkbox"/> Mirror Z	<input type="checkbox"/> Swap X-Z

The function bar contains five icons:

1. Help icon (question mark)
2. Add Adapter icon (disk with plus)
3. Remove Adapter icon (disk with X)
4. Cancel icon (X)
5. Confirm changes icon (disk with checkmark)

The Function Bar

The function bar of the Adapter Management Window it is represented by a series of button / function which are:

Help



This button show the help window.

New Adapter



This button allow you to **Add** a new Adapter.

Remove Adapter selected



This button allow you to **Remove** an Adapter.

Cancel



This button allow you to **Cancel** the modify.

Confirm changes





This button allow you to **Confirm** the modify.



The Adapter Fields

The adapter fields are:

Adapter Code 01

Adapter Code

The code of adapter. This field is mandatory.

Description ISO 50

Description

The adapter description.

Measure Unit Millimeters

Measure unit

The gage measure unit. It can be Millimeters or Inches.

X Value Diameter

X Value

The measure unit of X gage. It can be Diameter or Radius.

Ref. Adapter No Adapter

Ref. Adapter

Indicates whether the Adapter's X and Z dimensions are related to their own calibration edge or to a different calibration edge such as the one from a different reduction sleeve or the one from the main system spindle.

X 87.516

X

X dimension of reference Tool for the adapter. This field is mandatory.

Z -0.15

Z

Z dimension of reference Tool for the adapter. This field is mandatory.

Mirror X

Mirror X

If is checked this parameter the X gage will be mirrored (reversed of sign).

Mirror Z

Mirror Z

If is checked this parameter the Z gage will be mirrored (reversed of sign).

Swap X-Z

Swap X <-> Z

If is checked this parameter the X gage and the Z gage will be reversed: the X gage will refer to Z axis and Z gage will be refer to X axis.



THE TOOL MANAGEMENT WINDOW

The tool data

Tool Management			
Tool Code	T001		
Description	BORING BAR		
Adapter	01		
Measure Unit	Millimeters		
X Value	Diameter		
Measure Type	Relative		
	<input type="checkbox"/> Mirror X	<input type="checkbox"/> Mirror Z	<input type="checkbox"/> Swap X-Z
	Theor.	Lower Tol.	Upper Tol.
X	30	0	0
Z	120	0	0
Nose Radius	0	0	0
Insert Angle	0	0	0

The function bar

The function bar

The function bar of the Tool Management Window it is represented by a series of button / function which are:

Help



This button show the help window.

New tool



This button allow you to **Add** a new tool.

Remove Tool selected



This button allow you **Remove** the tool selected.

Cancel changes



This button allow **Cancel** the modify.



Confirm changes



This button allow **Confirm** the modify.



TheTool Field

The Tool Field are:

Tool Code | T001

Tool code
The code of tool. This field is mandatory.

Description | BORING BAR

Description
The tool description.

Adapter | 01

Adapter
The adapter code associated with tool. This field is mandatory.

Measure Unit | Millimeters

Measure unit
The gage measure unit. It can be Millimeters or Inches.

X Value | Diameter

X Value
The measure unit of X gage. It can be Diameter or Radius.

Measure Type | Relative

Measure Type
The gage representation method. It can be Relative or Absolute.

Mirror X

Mirror X
If is checked this parameter the X gage will be mirrored (reversed of sign).

Mirror Z

Mirror Z
If is checked this parameter the Z gage will be mirrored (reversed of sign).

Swap X-Z

Swap X <-> Z
If is checked this parameter the X gage and the Z gage will be reversed: the X gage will refer to Z axis and Z gage will be refer to X axis.

The tool gage fields are formed by

	Theor.	Lower Tol.	Upper Tol.
X	30	0	0
Z	120	0	0
Nose Radius	0	0	0
Insert Angle	0	0	0



- **Theor.:** there are the tool thorical geges;
- **Lower Tol.:** there are the tool lower tollerances;
- **Upper Tol.:** there are the tool upper tollerances.

This fields are refer to X gage, to Z gage, to Nose Radius and to Insert Angle.
The fields X and Z are mandatory.



THE "DIAL GAGE" FUNCTION

Menu Dial Gage



By clicking on the menu button Comparator will appear next to the vision system function Comparator.

Axis Display

The Vision System

Graphic and numeric Dial gage display

Dial gage accuracy

Type Prope

Measure results

The function bar

Adapter Code	Description	X	Z
01	ISO 50	87.536	-0.15
02	ISO 40	75.256	-0.236

Tool Code	Description	Adp	X	Z
T001	BORING BAR	01	30	120
T002	DRILL	01	10	120
T003	END MILL	01	40	85

Adapter: 01 ISO 50
Tool: T001 BORING BAR
Cutter: 0001

0.000 (Mm-D)

0.01 Mm | 0.001 Mm

Maximum X | Maximum Z
Minimum X | Minimum Z
Range X | Range Z



The function bar

The function bar of the Dial Gage Function Window it is represented by a series of button / function which are:

Help



This button show the help window.

Reset Dial Gage



It allows resetting the "Hand/Measure" of Comparator.

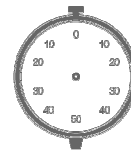

Saving measure



It allows to store the current measure and to use it to calculate the "Minimum", "Maximum" and "Range" displayed in the acquired measurements section.

Disabling Dial Gage Function



This button allows to disable the 'Dial gage' function and to return to the main window.

Confirm modify



This button allows you to initialize/reset the measures stored with the function



The graphic and numerical display of the current 'Dial gage' measure



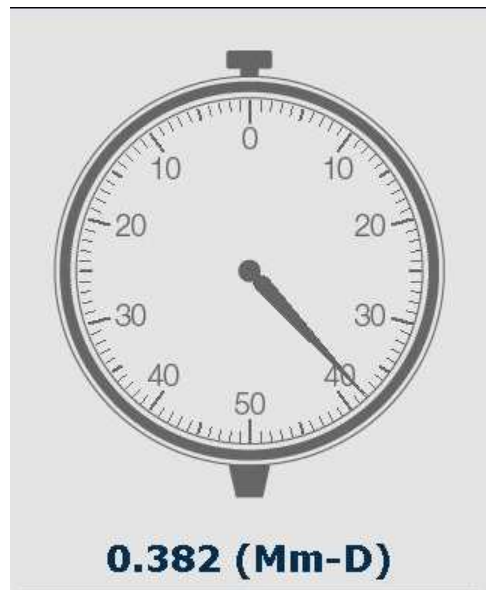

It indicates numerical and graphical form, the current measure and its units of measure, respectively as regarding millimetres or Inch, and diameter or radius

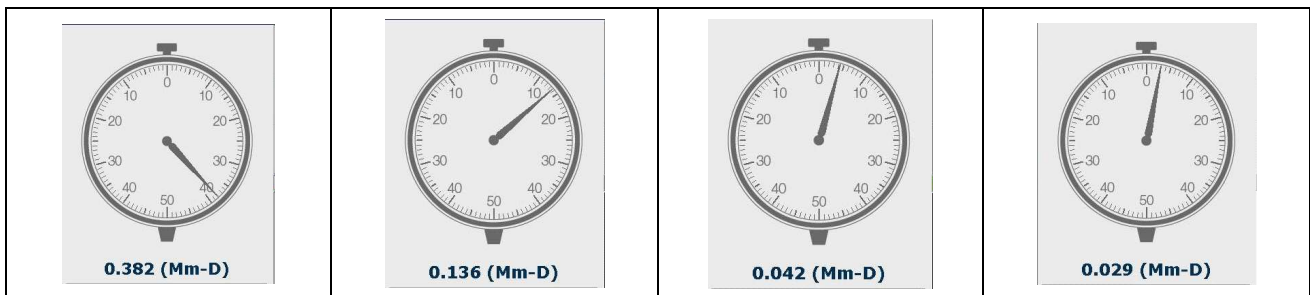

The displayed difference is compared to the last reset made with the function



The selection of the 'Dial gage' accuracy

It is possible to set the precision of 'Dial gage' that is the value of each notch of graphic display. The accuracy can be set 0.001 or 0.01 Millimetres or to 0.0001 or 0.001 Inch.



The section of the results of the stored measures

Maximum X	Maximum Z
71.886	
Minimum X	Minimum Z
71.886	
Range X	Range Z
0.000	



When storing a measure through the function  the system calculates the minimum, maximum and range values of acquired measures and displays absolute values in appropriate boxes.



The display of the quotes with their functions.

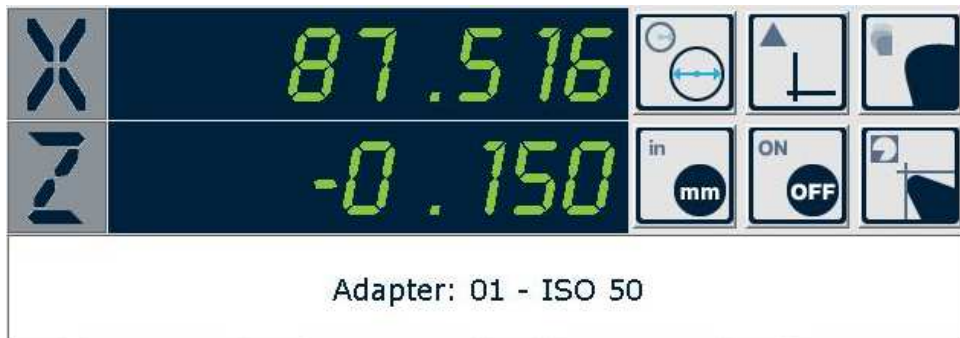

As for the main window there is a part concerning the display of quote/measures. For the functions details see the "Main Window" chapter. In this section are disabled the functions of

Reset	Max Profile	Freeze Quote	AutoMeasure

It is possible instead to set the units of measure with the functions

Mm/Inches	Diameter/Radius



The vision system with the position indicator tool





It displays the image and the measure with the indication of the optimal location of measure. For details on the functions refer you to "Main Window" chapter.

The selection of the type of "probe" of the 'Dial Gage'



It is possible to select between two different types of probe

 "Spherical" (It measures on a single point) – Horizontal (X axis)

 "Flat" (It measures the maximum on a surface)- Horizontal (X Axis)

 "Flat" (It measures the maximum on a surface)- vertical (Z Axis)



THE "RUNOUT" FUNCTION



Clicking on the icon of the menu runout will appear next to the vision system the management of runout.

Axis Display

Tolerance width X

Tolerance width Z

Data Release Width

The screenshot shows the main interface of the SIMPLE VISION software. It includes a table of tool data, a central display for X and Z axis measurements, and a bottom toolbar with various icons. Red lines connect callout boxes to specific elements in the interface.

Adapter Code	Description	X	Z
01	ISO 50	87.516	-0.15
02	ISO 40	75.256	-0.236

Tool Code	Description	Adp	X	Z
T001	BORING BAR	01	30	120
T002	DRILL	01	10	120
T003	END MILL	01	40	85

The function bar

The Vision System

Abilitates Minimum Z Memory

Tool Data and Measurements

Quote Graphic

Quote Graphic



The function bar

The function bar of the RunOut Function Window it is represented by a series of button / function which are:

Help



This button show the help window.



Cancel

Exit the RunOut Function.

RunOut X, RunOut XZ

It starts the Runout measurement procedure for the **X axis only**



It starts the Runout measurement procedure for **both axis**.

Once the Runout function is activated, the vision system will show either one or two lines, one green and one red (Horizontal and/or Vertical depending on the Runout that was chosen) which determine the limits within which the system will measure.

At this point, the system is ready to recognize the size of the different inserts or cutting edges. The user has to rotate manually so that all edges can be focused. When the insert passes within the measurement ranges, as determined by the green and red lines, the machine will measure automatically and the measurements will be shown in the data and graphics sections.

When activating the function e/o in front of the measurement data, the utilities bar will show new icons, which are:

Quote Saving

Only available if a tool measurement is activated, it saves the measured values in the measurements grid in the main window.

Print Label

It prints a lable with the Runout data.

Stampa u

Repeat data Acquisition

Initializes the data relevated and gets ready for a new measurement.

Conicity

It starts the procedure to measure the tool's conic shape.

Before starting the procedure, place the machine where the measurement



of the diameter is to be made in order to calculate the angle, then activate the procedure and rotate the tool in order to measure the inserts. When each insert passes by, the system, through the same procedure as with the Runout function, makes the measurements and updates the values of the conic shape angles.

Review the measurement Results



It allows to recalculate and review the measurement data applying new Permette parameters of tolerance imposed.

Finalize RunOut



Finalizes the Runout procedure in order to start a new one. The graphics and data will be refreshed.

Clicking the desired cutting edge on the graphic it will turn blue allowing it to be regulated.

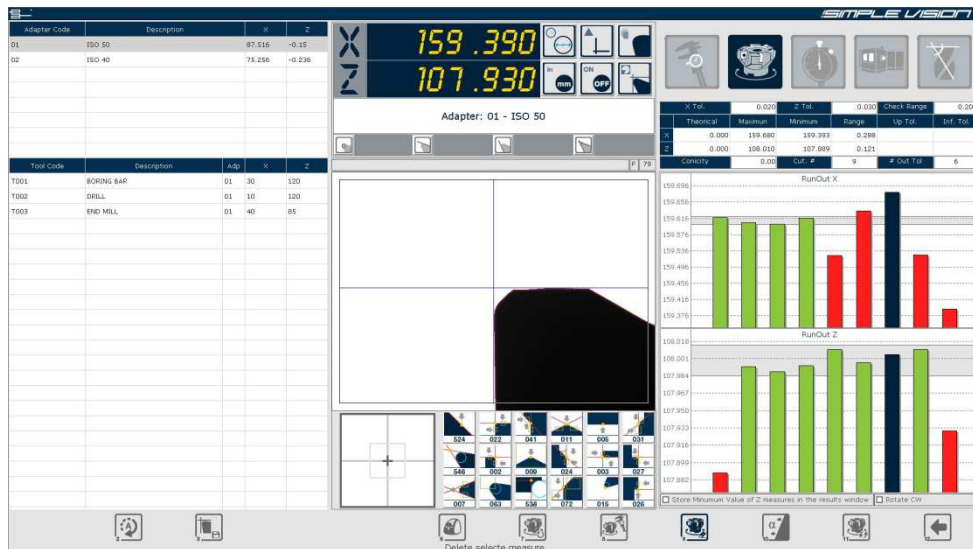

Cutting Edge regulation



It starts the procedure for the regulation of the selected cutting edge.

The following functions will then be available:



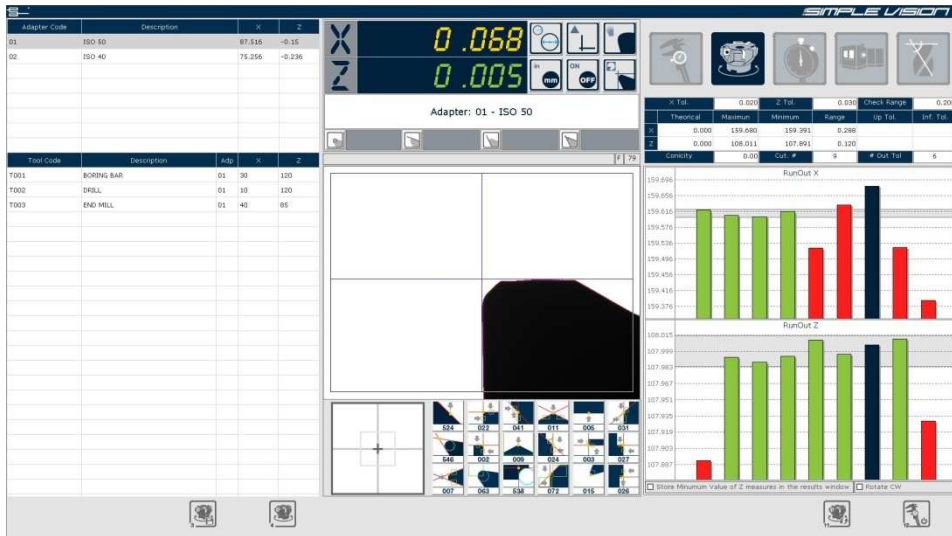

A display of the quotas will show the offset with respect to the theoretical value.

Memorizes a New Quota in the Graphic



When acquiring a new measurement the new quotas will substitute the previous ones. The Data area and the related graphics will be updated immediately showing the new measurement.

Regulation End



It finishes the regulation of the selected Cutting edge.

Refresh the Graphic



It shows the new graphic with the renovated data and v
ir

The RunOut Data

The data that can be introduced in terms of measurement tolerances is the following:



- Toll. X: Identifies the value of the tolerance width for the X axis.
- Toll. Z: Identifies the value of the tolerance width for the Z axis.
- Width released.: It identifies the value of the width band of the tool.

The data just described can be modified using the previously described key or button. I

The data calculated automatically is the following:

- N. Edges: Number of Edges.
- Edges Out of Tolerance: indicates the number of edges out of tolerance.
- Conic Shape: identifies the value of the conic shape of the tool (If the procedure is in use).

In the Grid, with respect to the X and Z axis, the following is shown:

- Theoretical: Theoretical value of the imposed Quota for the tool (If active).
- Maximum: indicates the maximum measured value.
- Minimum: indicates the minimum measured value
- Range: indicates the Range between the maximum and minimum values.
- Toll. Sup.: Maximum superior tolerance set (if active).
- Toll. Low.: maximum lower tolerance set (if active).

The RunOut Graphics

The Runout Graphics show in a Graphic way the measurement of the the cutting edges measured in the Runout. Each single histogram corresponds to a cutting Edge and may have different colors:

- GREEN: The cutting Edge is within tolerance.
- RED: The cutting Edge is not within tolerance.
- BLUE: the cutting Edge is being regulated.

Further characteristics of the Runout Graphic are the tolerance and the theoretical value. The Tolerances can be of two types:

- **The Tool Tolerance:** This one is designed by a Blue line and it identifies the tolerance value of the tool as declared in the Data Management function.
- **The Runout Tolerance:** This one has priority over the Tool's tolerance, and can't be greater than it. (eg: If the tool's tolerance was ± 0.015 mm the range of the RunOut



can not be greater than 0.030 mm). It is designed by a yellow line and is calculated dynamically. It is placed so as to include as many cutting edges as possible. The theoretical value instead, is designed with a Pink line, and indicates the theoretical quota of the tool as declared in the Tool Management function.

It is possible to abilitate the parameter.

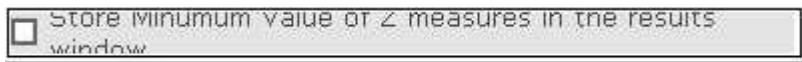

Which allows to memorize the Minimum and maximum values of the Z axis (Which means saving them in the measurements grid of the main window), del valore **Minimo** rilevato sull'asse Z anziché il valore **massimo**.



THE POSTPROCESSOR MANAGEMENT



Menu PostProcessor

Clicking on the icon of the menu PostProcessor will appear next to the vision system the management of PostProcessor.

The screenshot displays the SIMPLE VISION software interface. At the top left, there is a table for 'Adapter Code' and 'Description' with columns for X and Z coordinates. Below it is a 'Tool and Measurement grid' table with columns for Tool Code, Description, Adp, X, and Z. The main area features a 'Tool list' table with columns for Sel., Position, Tool Code, Adapter, t/R, X, Min/In, Z, Description, Nose Radius, and Insert Angle. Below the tool list is a 'Post Processor list' showing 'AllFieldBase.PNC' and 'TutCampBasePost.PNC'. To the right of the postprocessor list is an 'Output selection' panel with radio buttons for File, Screen, Floppy, Dnc, Seriale 1, Seriale 2, and Printer. Below that is a 'General parameters' section with checkboxes for Diameter, Offset X, Offset Z, Milling, Millimeters, Radius, Beal X, Beal Z, Lathe, and Inches. At the bottom of the interface is a 'The function bar' containing various icons for help, tool management, and other functions.

Tool and Measurement grid

Output selection

The function bar

List of available Postprocessors

Postprocessors Parameters



The function bar

The function bar of the PostProcessor Management Window it is represented by a series of button / function which are:

Help



This button show the help window

Generate



It generates the measurement data in the MachineTool format based in the kind of Postprocessor and output selected.

Reset Tool



Cancel, after the confirmation request,



ALL the measurements, selected or not.



Cancel

Exit the PostProcessor function..

Review

Allows to review the tool list and selects all of them.

EditPost

Allows to create and modify the kind of PostProcessor. This function will be described in detail later on (see *Edit Post function*)

In order to select or deselect a tool from the grid, the user has to click on the tool's line.

X	T001	01	D	30.001	Mm	120 BORING BAR
---	------	----	---	--------	----	----------------

The data will then be evidenced with an X symbol.

Those that haven't been selected will not be evidenced.

	T002	01	D	10.001	Mm	120 DRILL
--	------	----	---	--------	----	-----------

During Data generation, only the selected tools will be taken into consideration.

It is possible to insert and modify with this procedure the position data, and the description of each tool. In order to modify some data, double click the desired cell.

	T003	01	D	40	Mm	85 END MILL
--	------	----	---	----	----	-------------

Provide the desired changes and confirm using the (Return) key from the key pad.

After having selected the tool, the desired Postprocessor has to be selected from the file availability list.



Select therefore the desired Output from the following:

- Video: generates output through video.
- File: generates a text file. If necessary, the system will ask the path and destination for the file to be saved.
- Floppy: generates output on a floppy;
- DNC: Personal procedure according to the needs for tool correction.
- Serial 1: generates output through port COM1
- Serial 2: generates output through port COM2
- Printer: sends the output directly to the printer.

Generates data by using the function "Generate"



EDIT POST FUNCTION

Given the great amount of Numeric Controls available, and the different programming methods, it is possible to create a PostProcessor file with which to define the data to generate, the sintaxis, the format and the measurement units. This Programming/Configuration can be carried out with the different instruments of the "EditPost" function. The EditPost window allows to modify or create a file to be used in order to carry out a Postprocessor.

Content/ instructions of the file for the Post

```

GEN : (Language:ITA)
REM : *** RIGA DI COMMENTO ***
GEN : (Diam/Raggio:Diam) (Diff/Reale:Reale) (DiffZ/RealeZ:DiffZ) (Ales/Tornio:Ales)
GEN : (AGGOSTK:0.02) (AGGOSTZ:-0.100) (FATMOLTk:1) (FATMOLTz:1)
Rem : (RIGA:V000 *) (IN:INRISICA:100)
GEN : (Mater:Mei) (NomeFile:C:\CampBasePost.out)
INT : (Data:.....) (DATA:##/##/##) (ora: (ORA:hh:mm:ss))
INT : (Numero Utensile: (TOTUT:##))
INT : (.....)
DATI: Codice Utensile.....: (U:(1)@=1/0*)
DATI: Descrizione Utensile.....: (U:(2)*0*)
DATI: Data Presetting.....: (U:(7)*dd/mm/yyyy*)
DATI: Posizione.....: (U:(11))
TAG : (Misure).....: (X:"0.000")
TAG : (Lunghezza Misura).....: (L:"0.000")
DATI: ***** RIGA DI SEPARAZIONE - NON METTE NULLA IN OUTPUT ***
NORI: *** DATI SENZA NUMERO DI RIGA ***
END : %
  
```

Toolbar comandS

The function bar



The function bar

The function bar of the Edit Post function Window it is represented by a series of button / function which are:

Help



This button show the help window.

Load



It allows to load the post configuration from those already existing.

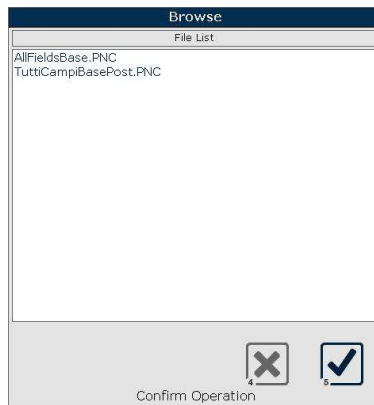

Select the configuration and confirm or cancel

New



Initialize data and allows to start the set up of a new Post Processor.

Inizializza
configura

Delete



Eliminates the Post processor configuration selected.

Back



Goes back to the POSTPROCESSOR MANAGEMENT window



By providing the different modifications to the configuration loaded , in the Utilities bar there will be further available options:

Save



Save the modify.

Save as



Save as a new configuration with a different name



Insert the new name and confirm  or cancel 

Commands Toolbar

Using the command Toolbar on the side, creating PostProcessor files becomes very simple. Clicking the different icons available, it is possible to introduce each single word or instruction necessary to manage the data. In order to change the type/section of data to be used, click on the list on top of the toolbar.

Each instructions line can be made up of fixed values, and/or language instructions. The instructions are always identified and always enclosed by the characters "|"
(|Instructions|).

Commands for line headers



Data:



Tool Data Command.



END:

This command is used to set the instructions that finalize the Post Processor procedure. This may be necessary when the Numeric Control asks for characters or instructions that allow it to interpret the end of the loading file of the tool index. It is possible to introduce several lines with the finalizing parameters.



GEN:

Command for general settings.



INT:

Command for the header.



NONE:

This icon introduces an empty line in the Post Processor procedure. In the case that the line numbers have been assigned in the general parameters, this line does not have a sequence number. It may be used also to interrupt the tool or insert management cycle.



NORI:

Command to split the Data Groups.



REM:

This command is used when it's necessary to introduce a comment inside the procedure. The lines identified with this command are ignored during the making of the Postprocessor.



SCRI:

service command: This icon inserts a line with fixed information. In case a number has been assigned to this line, in case that the line number has been assigned in the general parameters, this line is not numbered. It can be used



also to interrupt the management cycle of the tool or insert management



TAG:

Command for Cutting Edge Data.

Commands for general settings

These Commands are used to set some general criteria which are applied in the phase when the tool index is being generated.

The line identification for these command e **GEN**, and it is possible to introduce a line of this type.

The kind of machines that may be selected are either Turning or Milling machines.

The sintaxis is the following:



|Ales/Turning:Ales|

For Milling machines



|Ales/Turning:Turning|

For turning machines

When the type of machine selected is a Turning machine, the value of the measurements are automatically inverted when generated.

The following parameters are used to set the general criteria of the tool quotes independently of how they have been defined and measured.



Select Millimeters/Inches:



mm/Pollici:Mm|

The quotes will be esprese in Milimeters.



mm/Pollici:Pollici|

The quotes will be esprese in Pollici

Select Quota X in Radius/Diameter:



|Diam/Raggio:Diam|

The quotes will be esprese in Diameter



|Diam/Raggio:Raggio|

The quotes will be esprese in Radius



|Language:(Lingua)|

Select the kind of language to be used



|DATA:"Format"|

Introduce the current data in the system. It indicates the format in which it's presented.



|ORA:"Format"|

Introduce the current time in the system. It indicates the format in which it's presented.



**|TOTUTE:"Format"|**

Introduces the total number of tools.

**|NOMEFILE:"Nome File"|**

Introduces the file name of the user.

**|LINE:"Line Number"|**

Introduces the line number.

**|AGGCOSTX:"Offset Value X"|**

Allows to introduce an offset value for X. This offset value will be applied to all the real X which will be processed.

**|AGGCOSTZ:" Offset Value Z"|**

Allows to introduce an offset value for Z. This offset value will be applied to all the real measurements of Z which will be processed.

**|ININUMRIGA:"Value"|**

Allows to decide the initial value for the line numbers.

**|FATTMOLTX:"Value"|**

Allows to apply a multiplication factor for X. It may be used in the case that measurements have to be introduced in microns and millimetres for example.

(|FATTMOLTX:1000|).

**|FATTMOLTZ:"Value"|**

Allows to apply a multiplication factor for Z. It may be used in the case that measurements have to be introduced in microns and millimetres for example.

(|FATTMOLTZ:1000|).



Commands for Tool data

These commands are used to extract the data from the files which are processed for all the tools being examined.

Reference will be made to the field format as indicated with «**Format**» which has the functionality later described.

The line identification for these commands is DATA.

The system processes all the consecutive lines with DATA for each tool.

The instructions for this command category are the following:



|U:(1)|

Command for introducing the **Tool Code**.



|U:(2)|

Command for introducing the **Description**.



|U:(14)|

Command for introducing **The Adapter Code**.



|UI:(7)"Formato"|

Command for introducing **Presetting Data**.



|UI:(11)|

Command for introducing the **Position**.



|X:"Formato"|

Command for introducing **X quote measure**.



|Z:"Formato"|

Command for introducing **Z quote measure**.



Most used commands (Recent)

The most used commands are memorie in this section.

The Formats

Selecting one data with a button from the toolbar on the side, if a format has to be introduced, the following window will show up:

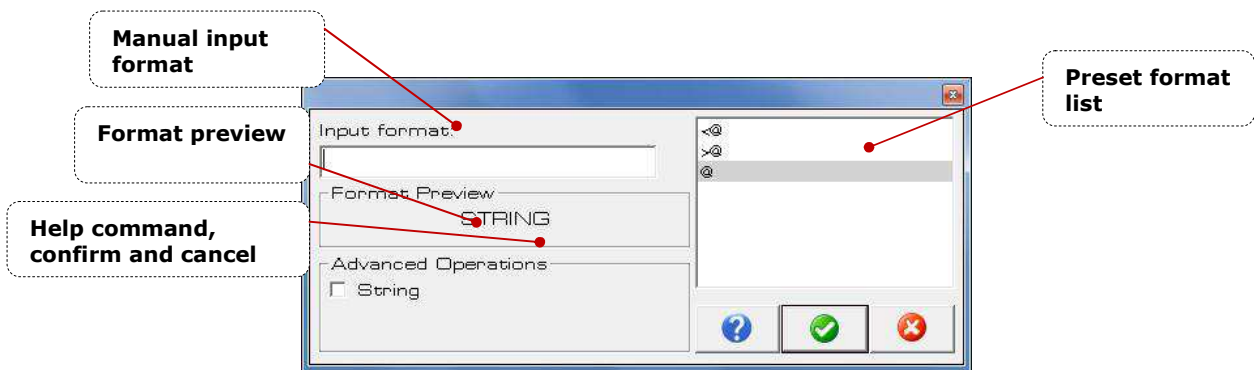

From this list, it will be possible to do the following:

- Introduce manually the format through the field "**Manual Input Format**". For an optimal use, it is advised to check the guide of available formats by clicking the help icon.
- Check the format preview.
- Select a preset format from the availability list.

To confirm the format chosen, click confirm or either cancel.



THE BACKUP AND RESTORE WINDOW

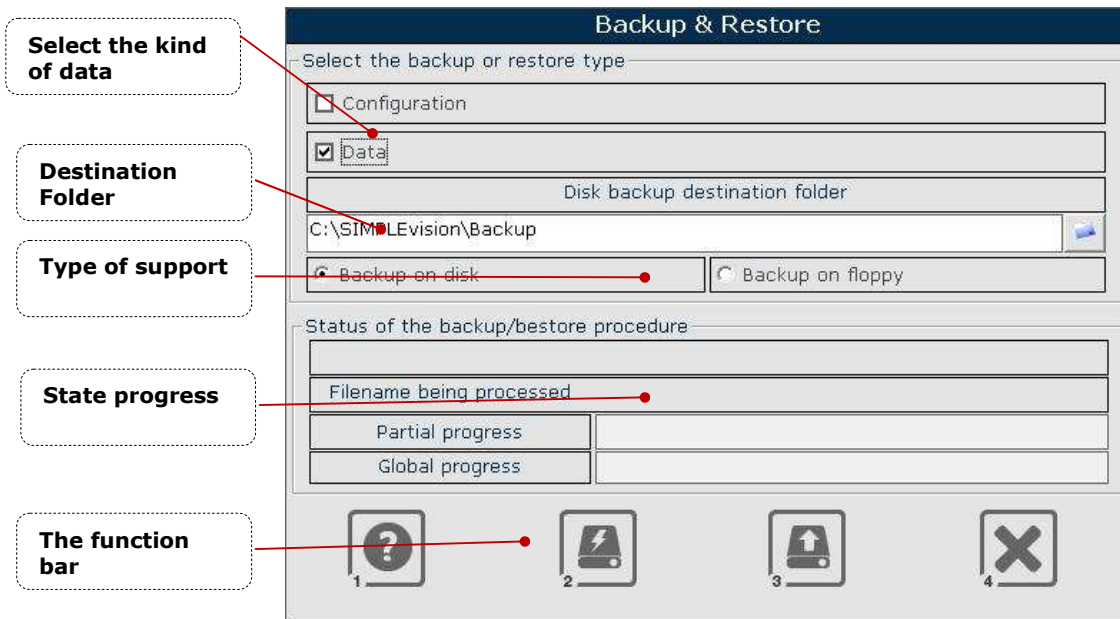

The function bar

The function bar of the Backup and Restore Window it is represented by a series of button / function which are:

Help



This button show the help window.

Run Backup



Run the type of **Backup** selected.

Run Restore



Run the type of **Restore** selected..

Cancel





Close the window and return to the previous



The Backup and Reset information

During the backup or Reset procedures, there are different parameters and information which is the following:

- **The kind of backup or Reset**

These parameters define the kind of backup or reset.

Configuration: The procedure will apply to the system configuration files.

Data: The procedure will apply to data 8 and therefore the database with the definitions for tools indexes, adapters cycles and macros).

- **The backup destination**

It is possible to select a backup destination different from that applied by default. Clicking on the search icon, a window from which to select the destination folder will show up.

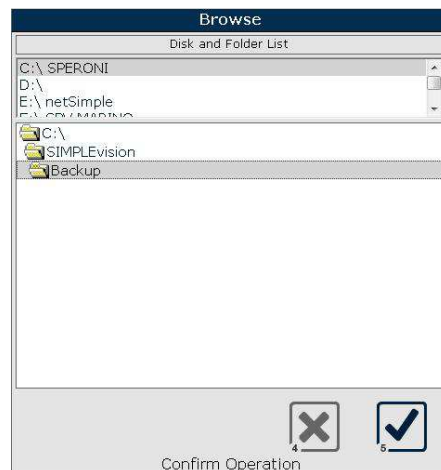

There is furthermore the possibility of doing the backup on a floppy.



- **Restore Destination**

It is possible to select a destination disc for the restore. This may be necessary in case that the machine is linked via network.

- **The progress of Backup and Reset**

Once the procedure has been launched, all the selected modes will be carried out. During the execution the status will show as well as the file being processed:



Once the procedure is over, a message will show .

THE OPTIONS WINDOW

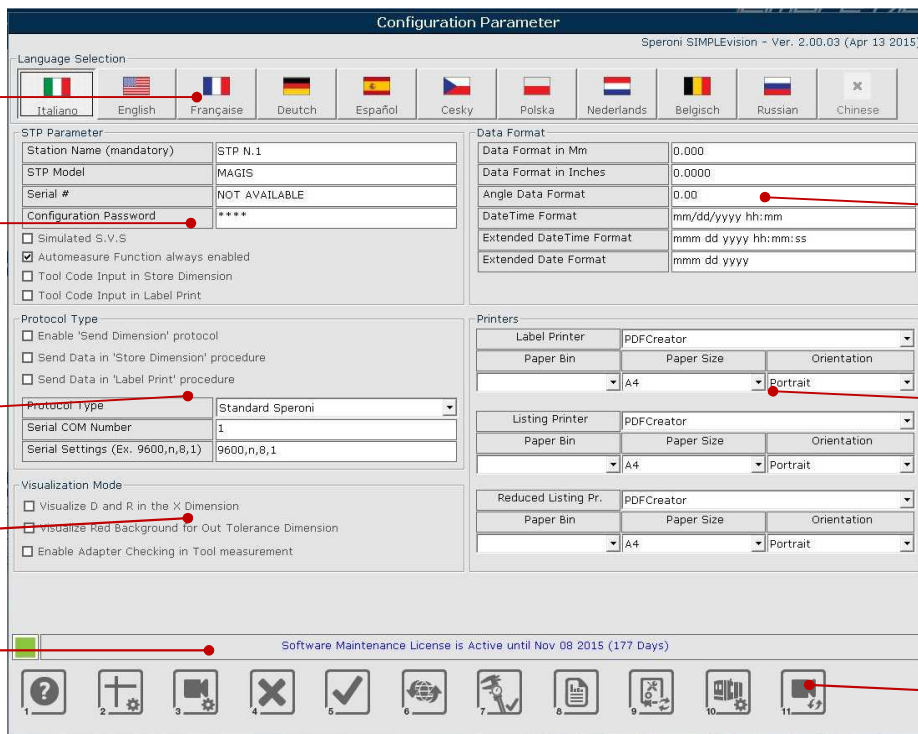

The Language Settings

STP Parameters

Serial Communication Parameters

Display Parameters

"Software maintenance" contract status

The Data Format

Printers Configuration

The function bar



To access this window you must digit an authentication password.
There are two access levels:

Level 1

The password for this level is "UPGRADE" and can not be changed. At this level the user can do the following:

- Check parameters.
- Renew the Software maintenance contract.
- Carry out a software update with the aid of a guided procedure.

Level 2

The initial password for this level is "USER" and may be changed. At this level the user can do the following:

- Modify the parameters (at least the STP definition parameters)
- Renew the Software maintenance contract.
- Carry out a software update with the aid of a guided procedure.



The window with the password request is the following:



To confirm the entry of the password push **Confirm**



Else push **Cancel**



The function bar

The function bar of the Options Window it is represented by a series of button / function which are:

Help



This button show the help window.

Cancel changes



This button allow you to **Cancel** the modify and return to the previous.

Confirm changes



This button allow you to **Confirm** the modify. It will run a Automatic restart of the Application.





Upgrade Manager

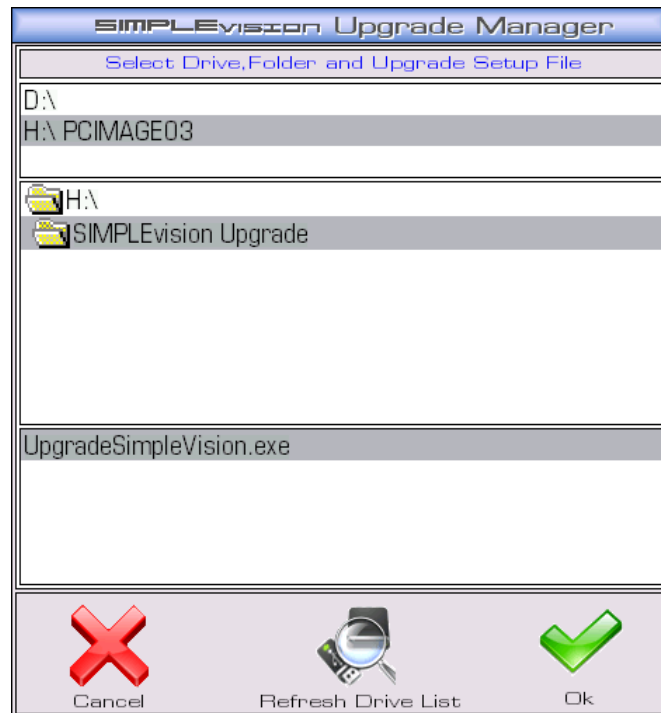

This button allows to launch the software updating procedure. It is only possible if the maintenance contract is active, and it consists of a single file (.exe). This file may be sent directly from Speroni SpA or downloaded through a link provided by the company. The file will then have to be copied with the same name on a removable device (USB or CD/DVD). Once the procedure is activated, the system asks for the selected destination and the path for the update.



The function  allows to visualize the list of removable devices available.

In order to cancel the file generation, use . The system will reset automatically.

In order to start the update procedure select the Drive, the folder and the file, and confirm with . An automatic procedure will update the software, and the system will refresh itself automatically.



Renew the Software maintenance Contract.



This button allows to start the procedure to renew the Software maintenance Contract.

In order to renew this contract, it is necessary to contact Speroni Spa and send the registration Code that will show up in this function. The code may be sent directly, or else, a file can be generated with the necessary information, using the function



The following window will show up to allow to choose the kind of device (Floppy o USB Key)

The function  allows to see the list of removable devices. In order to cancel



the file generation, use. 

In order to generate the file, select the desired drive and confirm with .

A message will indicate the name for the file generated, and if the procedure took place correctly.





Once the activation code is received, introduce it in the appropriate space. If it has been sent via file, copy it in a removable device and use the function.

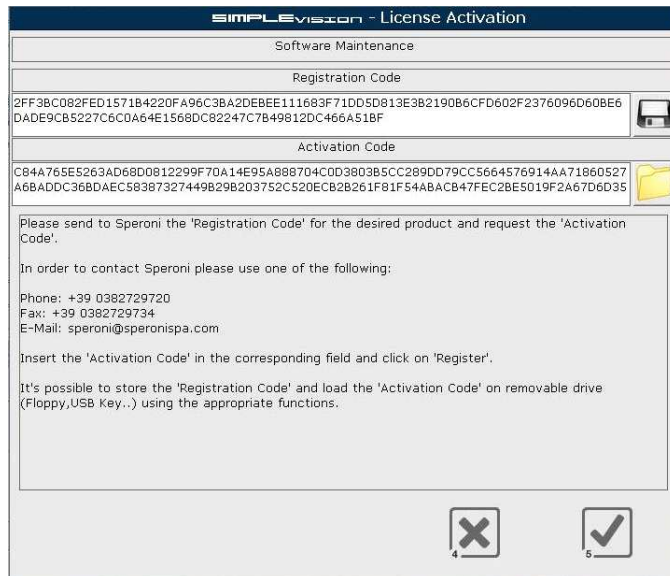

As it happened with the file creation, the available devices list will show up.

Select the correct drive and confirm with .
Confirm the activation code as introduced or imported



Using the function .
The status of the software maintenance contract will be updated.

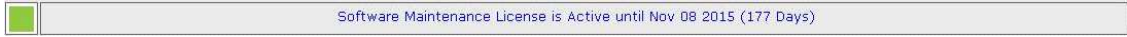

PostProcessor Parameters



This button allows to go to the postprocessor parameter management.. (See "PostProcessor Parameters")

The language settings

To choose the language push the button with the nation flag desired:

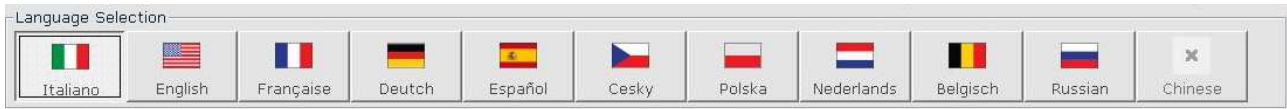

The selected language that will be used to confirm parameter change.

The STP Parameters

STP Parameter	
Station Name (mandatory)	STP N.1
STP Model	MAGIS
Serial #	NOT AVAILABLE
Configuration Password	****
<input type="checkbox"/> Simulated S.V.S <input checked="" type="checkbox"/> Automeasure Function always enabled <input type="checkbox"/> Tool Code Input in Store Dimension <input type="checkbox"/> Tool Code Input in Label Print	

Station Name (mandatory)	STP N.1
STP Model	MAGIS
Serial #	NOT AVAILABLE

Station name
The name of the work station. This field is mandatory and it can't be empty.

STP Model
Indicates the machine model. This data is set by Speroni.

STP License Plate
Indicates the number of reference of the



Simulated S.V.S

Automeasure Function always enabled

machine. This data is set by Speroni.

Simulated S.V.S.

Simulated Vision System.

AutoMeasure function always enabled

If this parameter is checked, on start up the Vision System switch to AutoMeasure function automatically.



Tool Code Input in Store Dimension

Tool code input in "Store Dimension"

If this parameter is checked it will asked the tool code, if you have not selected a tool, by operator input, during the "Store Dimension" function.

Tool Code Input in Label Print

Tool code input in "Label Print"

If this parameter is checked it will asked the tool code, if you have not selected a tool, by operator input, during the "Label Print" function.

Serial communication parameters

Protocol Type	
<input type="checkbox"/>	Enable 'Send Dimension' protocol
<input type="checkbox"/>	Send Data in 'Store Dimension' procedure
<input type="checkbox"/>	Send Data in 'Label Print' procedure
Protocol Type	Standard Speroni
Serial COM Number	1
Serial Settings (Ex. 9600,n,8,1)	9600,n,8,1

Serial Communication Enabled

Serial Communication Enabled

If this parameter is checked SIMPLEvision can communicate with serial port.

Send Data in 'Store Dimension' procedure

Send data in "Store dimension" procedure

If this parameter is checked the measure will be sent through the RS232 communication port during the "Store Dimension" procedure.

Send Data in 'Label Print' procedure

Sending quote in "Print Label"

If this parameter is checked the measure will be sent through the RS232 communication port during the "Label Print" procedure.



Protocol Type	Standard Speroni
---------------	------------------

Protocol type

With this parameter you can set the protocol of serial communication that can be:

- Standard
- Cincinnati
- Mazak
- Makino
- Mori-Seiki
- Speroni Post

The protocols details will be described later.

Serial COM Number	1
-------------------	---

Serial COM Number

It specifies the number of serial port to use.

Serial Settings (Ex. 9600,n,8,1)	9600,n,8,1
----------------------------------	------------

Serial Setting

They are the settings of serial port.

The Data Format

Data Format	
Data Format in Mm	0.000
Data Format in Inches	0.0000
Angle Data Format	0.00
DateTime Format	mm/dd/yyyy hh:mm
Extended DateTime Format	mmm dd yyyy hh:mm:ss
Extended Date Format	mmm dd yyyy

The data format fields are:

Data Format in Mm	0.000
-------------------	-------

Data format in Mm

The format of millimeters data.

Data Format in Inches	0.0000
-----------------------	--------

Data format in inches

The format of inches data.

Angle Data Format	0.00
-------------------	------

Angle Data format

The format of angle data.

DateTime Format	mm/dd/yyyy hh:mm
-----------------	------------------

DateTime format

The format of dates and time data.

Extended DateTime Format	mmm dd yyyy hh:mm:ss
--------------------------	----------------------

Extended Date Time format

The format of extended dates and time data.

Extended Date Format	mmm dd yyyy
----------------------	-------------

Extended Date format

The format of extended dates data.

The visualization mode parameters

Visualization Mode

- Visualize D and R in the X Dimension
- Visualize Red Background for Out Tolerance Dimension
- Enable Adapter Checking in Tool measurement

The visualization mode parameters are:

Visualize D and R in the X Dimension

Visualize "D" and "R" in the X dimension

If this parameter is checked the label of X gage change in "D" or "R".

Visualize Red Background for Out Tolerance Dimension

Visualiza Red background for Out Tolerance dimension

If this parameter is checked when the dimension are out tollerance the gage background is red.

Enable Adapter Checking in Tool measurement

Enable Adapter check in "Store dimension" procedure

If this parameter is checked SIMPLEvision ask you if the tool adapter is correct with the "Adapter checking management".

The Layout of Printers



Printers		
Label Printer	PDFCreator	
Paper Bin	Paper Size	Orientation
	A4	Portrait
Listing Printer	PDFCreator	
Paper Bin	Paper Size	Orientation
	A4	Portrait
Reduced Listing Pr.	PDFCreator	
Paper Bin	Paper Size	Orientation
	A4	Portrait

It is possible to layout 3 Printers:

Label Printer

Label Printer	PDFCreator
---------------	------------

Listing Printer (Complete Print Measures)

Listing Printer	PDFCreator
-----------------	------------

Reduce Listing Printer (Redue Printer Measures)

Reduced Listing Pr.	PDFCreator
---------------------	------------

The Printer is selectable from a predefined list viewing by clicking on the key next the selections

Among the selections there is an empty row that means " No Printer"

Listing Printer	
-----------------	--

For each Printer is possible to layout respectively



Paper Bin	Paper Size	Orientation
▼	A4 ▼	Portrait ▼

Power Paper Bin, Paper/Label Size and Orientation (Horizontal/Vertical)



PostProcessor Parameters

Using the function  you are presented with the configuration data of Postprocessors

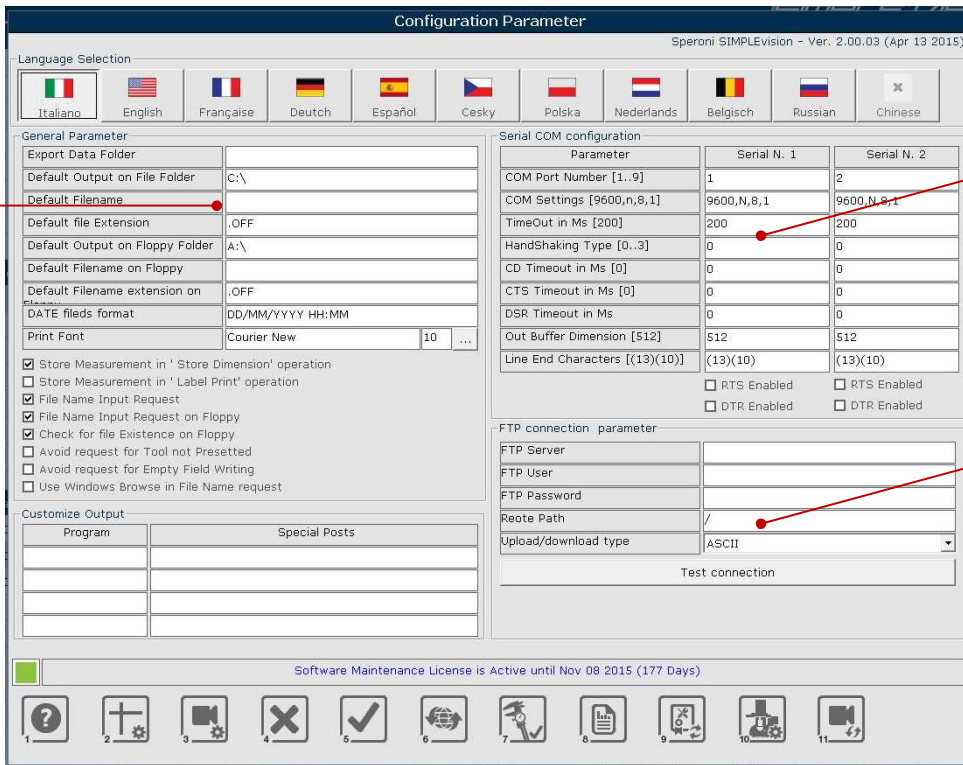

General Parameters

Protocol Serial Parameters

Custom PostProcessor

To return to the standard configuration parameters, use the function  .



General Parameters

General Parameter	
Export Data Folder	
Default Output on File Folder	C:\
Default Filename	
Default file Extension	.OFF
Default Output on Floppy Folder	A:\
Default Filename on Floppy	
Default Filename extension on Floppy	.OFF
DATE fields format	DD/MM/YYYY HH:MM
Print Font	Courier New 10 ...
<input checked="" type="checkbox"/> Store Measurement in ' Store Dimension' operation <input type="checkbox"/> Store Measurement in ' Label Print' operation <input checked="" type="checkbox"/> File Name Input Request <input checked="" type="checkbox"/> File Name Input Request on Floppy <input checked="" type="checkbox"/> Check for file Existence on Floppy <input type="checkbox"/> Avoid request for Tool not Presetted <input type="checkbox"/> Avoid request for Empty Field Writing <input type="checkbox"/> Use Windows Browse in File Name request	

Export Data Folder	
--------------------	--

File generation Folder

Definition of the folder where the Output postprocessor files are created if this is the selection that has been made. It can be used when the name request parameters have been left out of use.

Default Output on File Folder	C:\
Default Filename	
Default file Extension	.OFF

Name and Extension Default generation folder

Folder with the file name, the corresponding extension by default as used when the name of the file to be generated is required.

Default Output on Floppy Folder	A:\
Default Filename on Floppy	
Default Filename extension on Floppy	.OFF

Extension and name folder by default for generation of file on floppy

Folder, file name and corresponding extension that are used for the request of the file name to be generated when floppy output is selected.

DATE fields format	DD/MM/YYYY HH:MM
--------------------	------------------

Default Format for field type data

Format used for the fields of type data unless specified otherwise in the instructions.

Print Font	Courier New	10	...
------------	-------------	----	-----

Print Font

Type of Font and size if the printer has been chosen for the output.

<input checked="" type="checkbox"/> Store Measurement in ' Store Dimension' operation

Use data generated in the Quote Saving



procedure

Allows the use by the Postprocessor of the data saved in the main Runout window.



Store Measurement in ' Label Print' operation

File Name Input Request

File Name Input Request on Floppy

Check for file Existence on Floppy

Avoid request for Tool not Presetted

Avoid request for Empty Field Writing

Use Windows Browse in File Name request

Use the data generated in the lable printintout procedure

Allows the use of the postprocessor of the memorie data in the main window .

File name Request

If the Output is on file, it allows for the name request.

File name request on floppy

If the Output is on floppy, it allows for the name request, and to overwrite it.

Message visualization

Allows to visualize a message if during the file generation of the data of the postprocessor tools that have not been preset are used, or data has not been gathered.

Use of the browse standard

Allows the standard file browsing function. This parameter allows the possibility of checking any folder within the different disks, and to create and cancel them.

Serial Communication Parameters

Serial COM configuration		
Parameter	Serial N. 1	Serial N. 2
COM Port Number [1..9]	1	2
COM Settings [9600,n,8,1]	9600,N,8,1	9600,N,8,1
TimeOut in Ms [200]	200	200
HandShaking Type [0..3]	0	0
CD Timeout in Ms [0]	0	0
CTS Timeout in Ms [0]	0	0
DSR Timeout in Ms	0	0
Out Buffer Dimension [512]	512	512
Line End Characters [(13)(10)]	(13)(10)	(13)(10)
	<input type="checkbox"/> RTS Enabled	<input type="checkbox"/> RTS Enabled
	<input type="checkbox"/> DTR Enabled	<input type="checkbox"/> DTR Enabled

It is possible to configurate 2 serial channels in order to send directly the data towards the Numeric Control. The parameters to provide must be in accordance with the corresponding settings for the CN.



Custom PostProcessor

Customize Output	
Program	Special Posts

These parameters allow to set the kind of personal postprocessor. This configuration must be conducted or guided by Speroni personnel.

Type of Protocol Serial

1. STANDARD SPERONI protocol

The data formta is:

```
t[ToolCode] <Cr>
[XDimType][XDim][UM] <Cr>
L[ZDim][UM] <Cr>
```

Where:

ToolCode = the code of presetted tool.

XDimType = "d" if the dimension is in Diameter, "r" if is in Radius

XDim = Diameter or Radius measure value
(Format +0000.000 in Mm, +000.0000 in Inches)



UM = " (Double Quotes) for Inches dimension, No character for
Mm dimension

ZDim = Height measure value
(Format +0000.000 in Mm, +000.0000 in Inches)

<Cr> = Carriage Return (No Line Feed). Ascii Value: 13

Example for measure in Radius, Millimeters

T00000001<Cr>r+0020.593<Cr>l+0102.044<Cr>

Example for measure in Diameter, Inches

T00000001<Cr>d+002.5936"<Cr>l+08.0442"<Cr>



2. STANDARD POST protocol (Enable only on SIMPLEvision)

The data formta is:

```
A[AdapterCode]<CrLf>
T[ToolCode]<CrLf>
[XDimType][XDim][UM]<CrLf>
L[ZDim][UM]<CrLf>
```

Where:

ZDim = Height measure value
(Format +0000.000 in Mm, +000.0000 in Inches)

AdapterCode = the code of adapter.

ToolCode = the code of presetted tool.

XDimType = "d" if the dimension is in Diameter, "r" if is in Radius

XDim = Diameter or Radius measure value
(Format +0000.000 in Mm, +000.0000 in Inches)



ZDim = Height measure value
(Format +0000.000 in Mm, +000.0000 in Inches)

UM = I for Inches dimension, M for Mm dimension

<CrLf> = Carriage Return and Line Feed. Ascii value: 13 and 10.

Example for measure in Radius, Millimeters

```
A01<CrLf>
T00000001<CrLf>
R+0020.593M<CrLf>
L+0102.044M<Cr>
```

Example for measure in Diameter, Inches

```
A01<CrLf>
T00000001<CrLf>
D+002.5936I<CrLf>
L+008.0442I<CrLf>
```



3. CINCINNATI protocol

The data formata is:

```
#[AdapterCode]<CrLf>
X=[XDim] [UM][D/R]<CrLf>
Z=[ZDim] [UM]<CrLf>
```

Where:

AdapterCode = the code of adapter.

XDim = Diameter or Radius measure value
(Format +0000.000 in Mm, +000.0000 in Inches)

UM = " (Duoble Quotes) for Inches dimesion, No character for
Mm dimension

D/R = "D" if the dimension is in Diameter, "R" if is in Radius

ZDim = Height measure value
(Format +0000.000 in Mm, +000.0000 in Inches)



<CrLf> = Carriage Return and Line Feed. Ascii value: 13 and 10.

Example for measure in Radius, Millimeters

```
#01<CrLf>  
X=+0020.593R<CrLf>  
Z=+0102.044<CrLf>
```

Example for measure in Diameter, Inches

```
#01<CrLf>  
X=+002.5936"D<CrLf>  
Z=+008.0442"<CrLf>
```



4. MAZAK protocol

This protocol send data on serial port on an Operator request.

The request is:

<Stx> (Ascii value 2)

The data format is:

#[AdapterCode]<CrLf>

X=[XDim]<CrLf>

Z=[ZDim]<CrLf>

Where:

AdapterCode = the code of adapter.

XDim = Diameter or Radius measure value
(Format +0000.000 in Mm, +000.0000 in Inches)

ZDim = Height measure value
(Format +0000.000 in Mm, +000.0000 in Inches)

<CrLf> = Carriage Return and Line Feed. Ascii value: 13 and 10.



Example for measure in Radius, Millimeters

#01<CrLf>

X=+0020.593<CrLf>

Z=+0102.044<CrLf>

Example for measure in Diameter, Inches

#01<CrLf>

X=+002.5936<CrLf>

Z=+008.0442<CrLf>



5. MAKINO, MORI SEIKI protocol

This protocol send data on serial port on an Operator request.

The request is:

q<Cr> (Ascii value: 113 and 13))

The data format is:

Z<s>=<s>[ZDim]<s>[DimType]<s>X<s>=<s>[XDim]<s>[D/R]<s>[MM/INCH]
<Cr><Cr><Cr>

Where:

ZDim = Height measure value
(Format +0000.000 in Mm, +000.0000 in Inches)

DimType = "I" for Relative, "A" for Absolute

XDim = Diameter or Radius measure value
(Format +0000.000 in Mm, +000.0000 in Inches)

D/R = "D" if the dimension is in Diameter, "R" if is in Radius



MM/INCH = "MM" for Mm dimension, "IN" for Inches dimesion

<Cr> = Carriage Return (No Line Feed). Ascii Value: 13

<s> = Blamk

Example for measure in Radius, Millimeters, Absolute

Z = +0102.044 A X = +0020.593 R MM<Cr><Cr><Cr>

Example for measure in Diameter, Inches, Relative

Z = +008.0442 I X = +002.5936 D IN<Cr><Cr><Cr>



THE ADAPTER CHECKING MANAGEMENT WINDOW

Adapter checking management.

Actual Selected Adapter for the measure.

01
ISO 50

Verify that the selected Adapter is correct.
To change the selected Adapter, click on the list below.

Adapter Code	Description
01	ISO 50
02	ISO 40







The Adapter Checking function allows to check if the adapter, selected during the tool presetting, is correct.

In this window there are the **selected Adapter**, the adapter list (for change the adapter if is necessary) and the navigation menu.

To make a change of adapter and simply click on the adapter that you want to select and click



To cancel storage quotas click **Cancel**



Clicking **Help**



It will access the help online SimpleVision on the window in question.



ENABLE EXIT TO OPERATING SYSTEM

From the Main page of SIMPLEvision, select "F12 – Start extended function ('Exit' and 'Utility')"

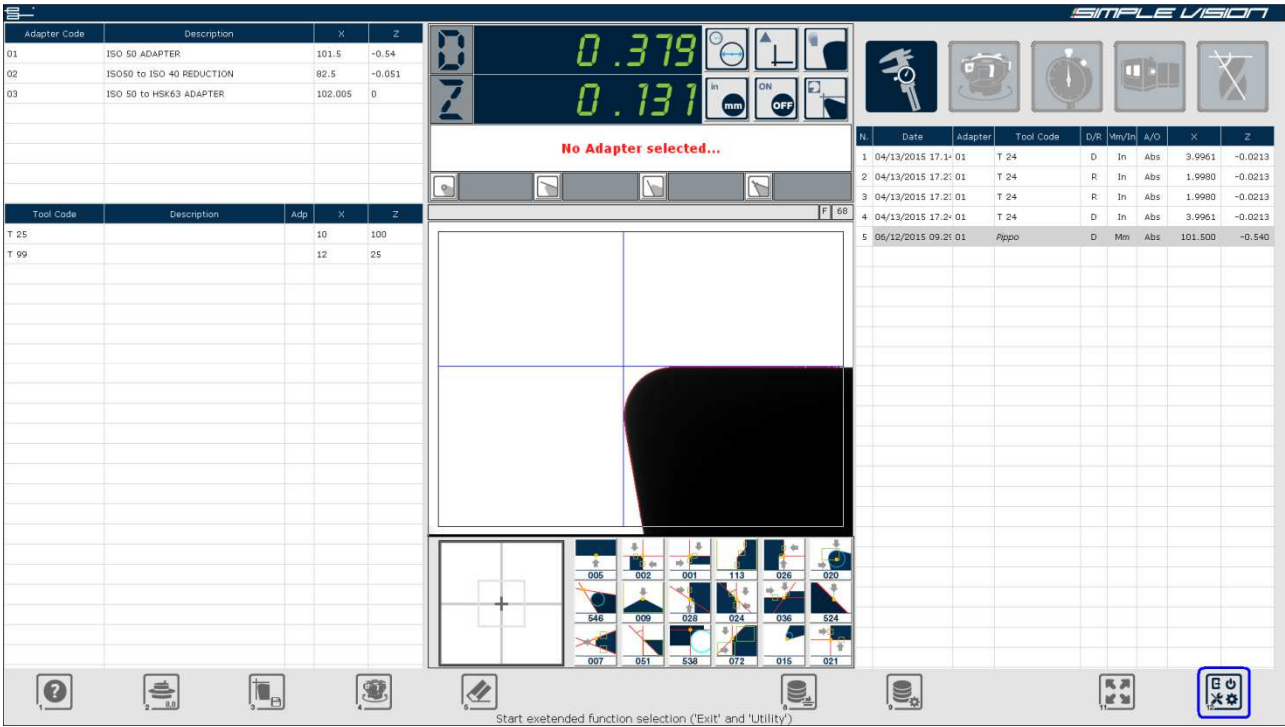

Select "F2 – System Configuration"

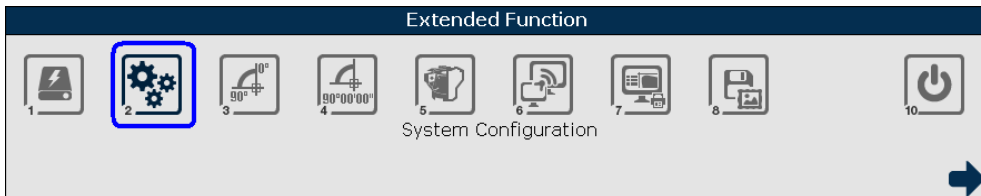

A password is requested. Insert the standard User password and select "F5 – Confirm operation".

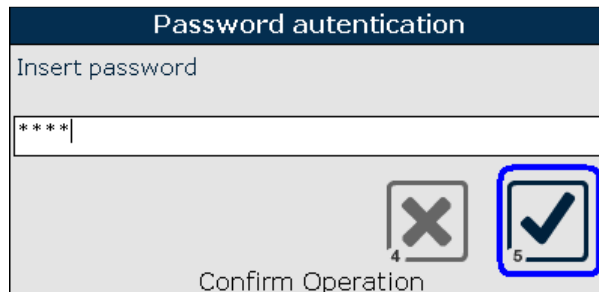

The configuration page below will be displayed. Select "F7 - Enable Exit to Operating System".

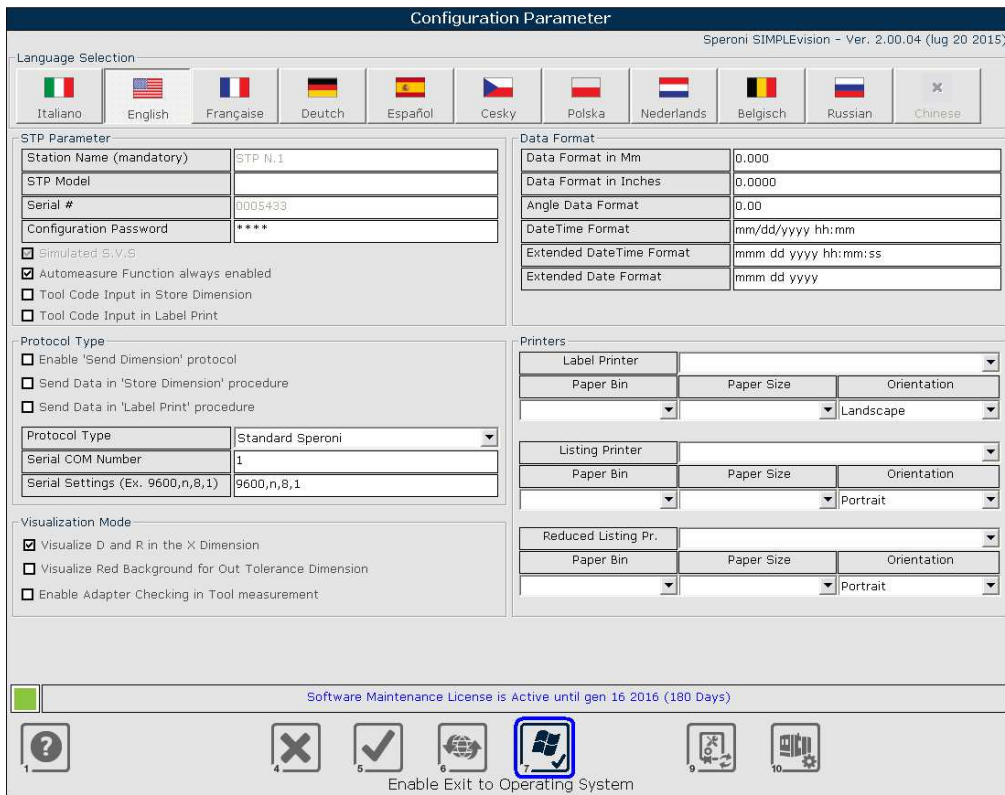

It is necessary to confirm the authorization to access to the operating system because this activity could compromise the functionality of the system. Confirming with "F5 - Yes" the warranty on the control will be void.

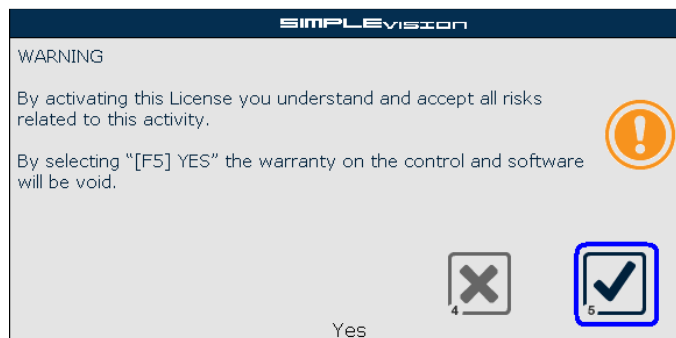

Exit from configuration page using "F4 – Cancel operation"

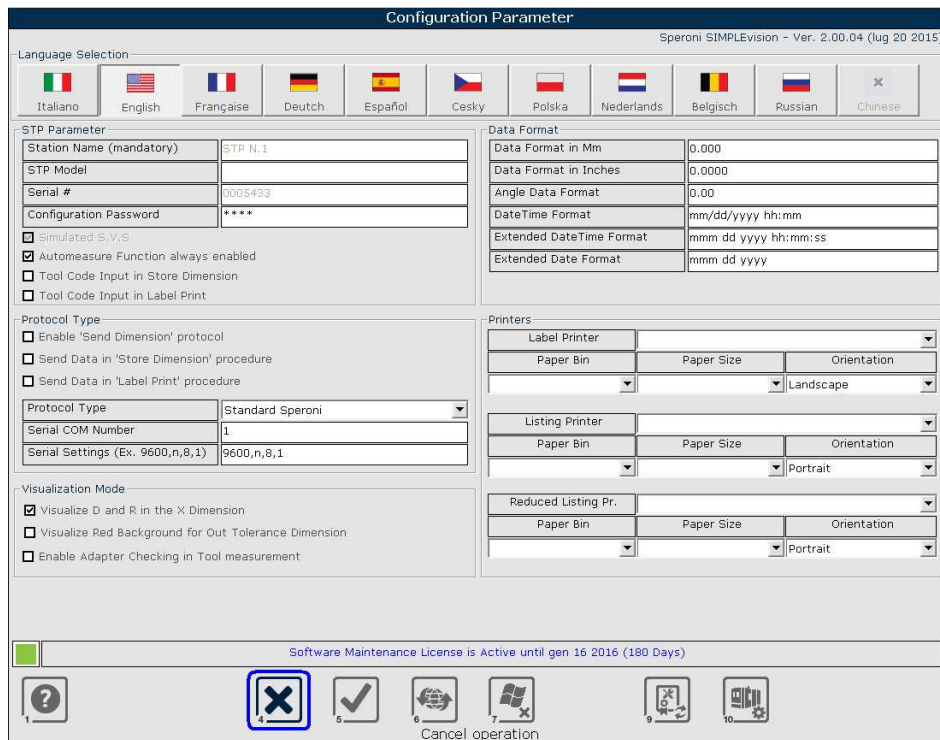

Accessing to the "F12 – Start extended function ('Exit' and 'Utility')" from the main menu, a new function "F11 – Exit to Operating System" can be used in order to access to Operating System.

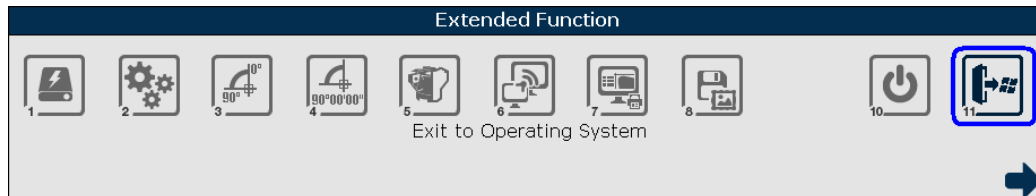

Confirm and accept the responsibility related to any malfunction of the system using "F5 – Yes".



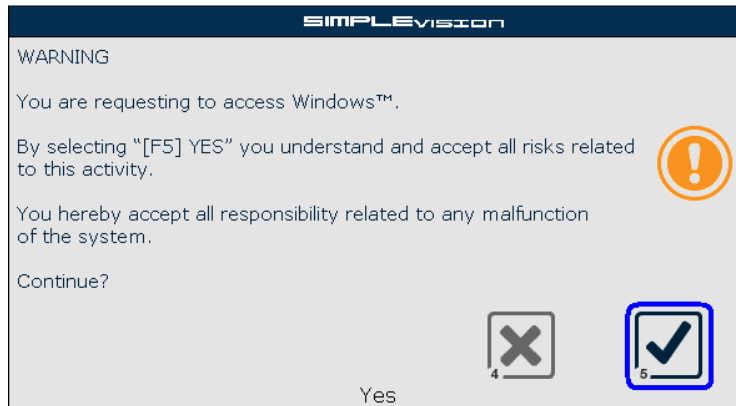

DISABLE EXIT TO OPERATING SYSTEM

From the Main page of SIMPLEvision, select "F12 – Start extended function ('Exit' and 'Utility')"

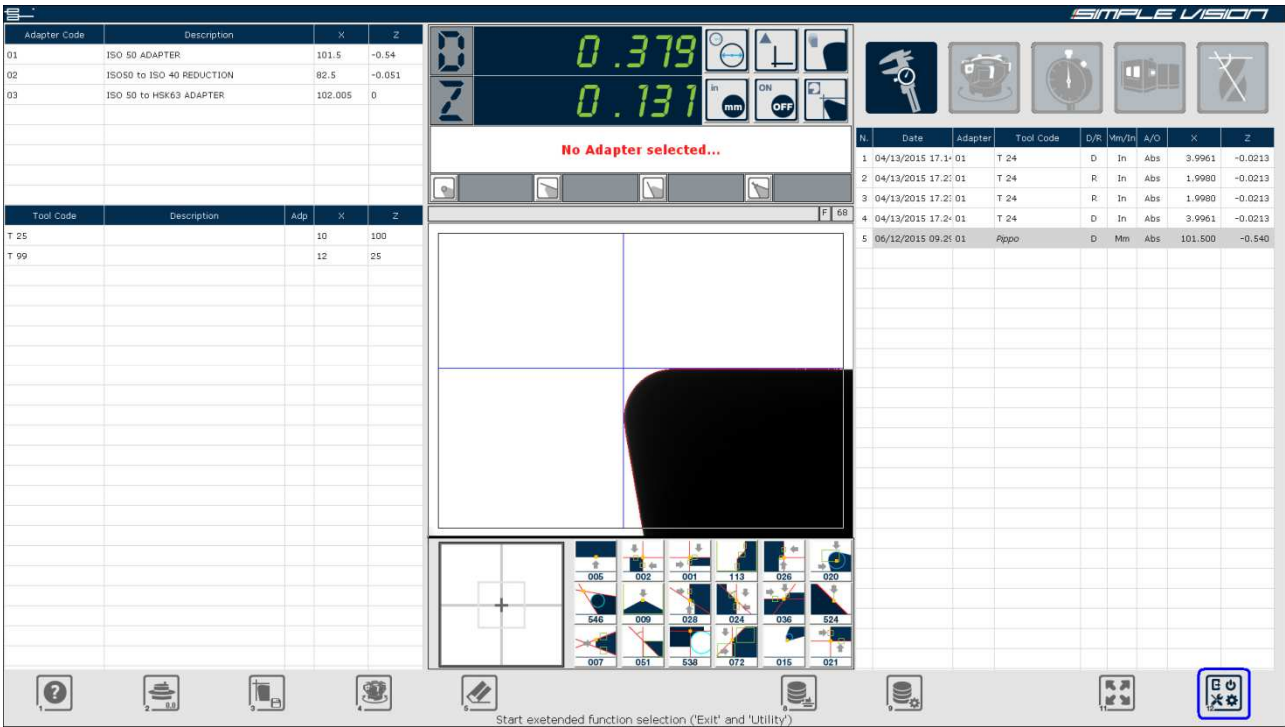

Select "F2 – System Configuration"

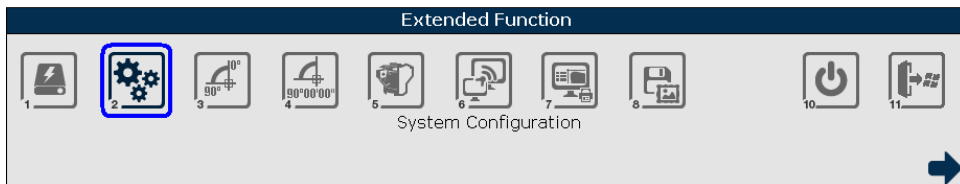

A password is requested. Insert the standard User password and select "F5 – Confirm operation".

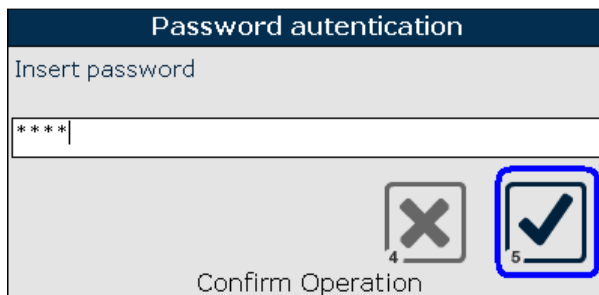

Use "F7 – Disable Exit to Operating System".

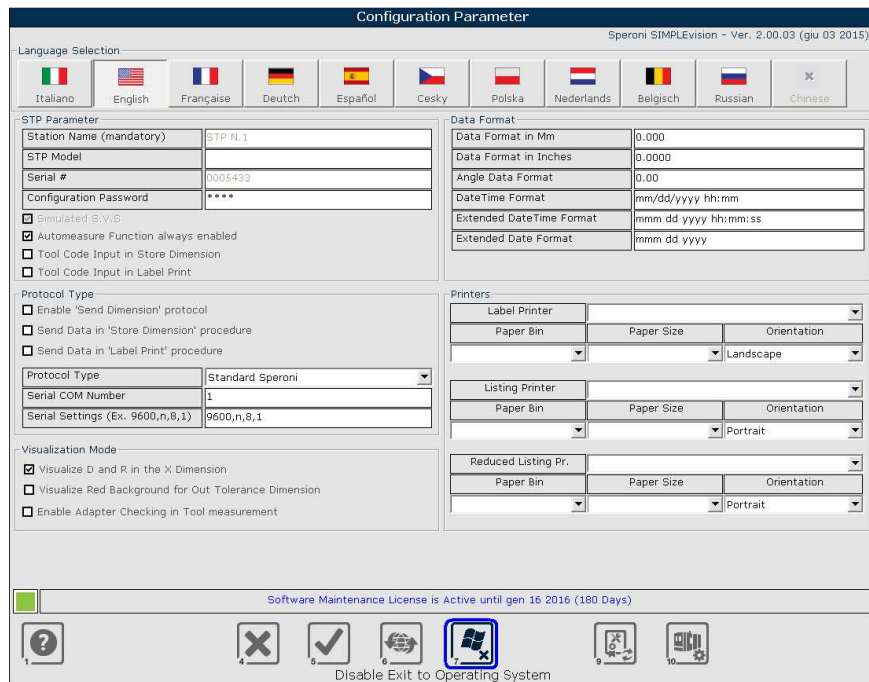

Exit from configuration page using "F4 – Cancel operation".

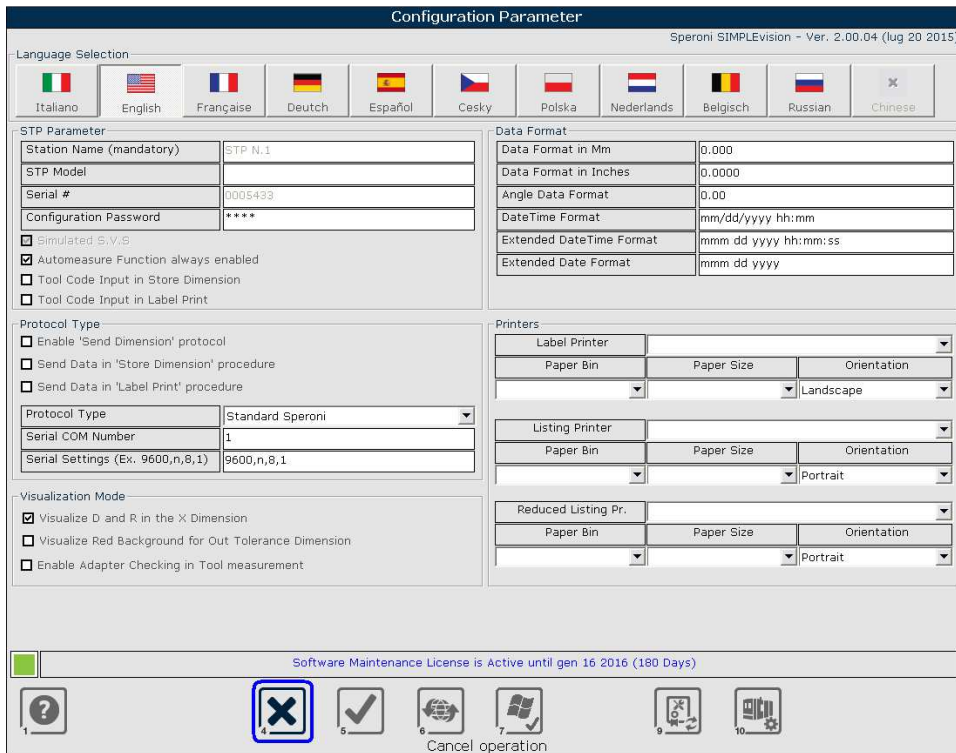

Accessing to the "F12 - Start extended function ('Exit' and 'Utility')" from the main menu, the function "F11 - Exit to Operating System" is not available





SPERONI spa · Via Po, 2 fraz. Sostegno - 27010 Spessa - PV - ITALIA
tel +39 0382 729720 · fax +39 0382 729734 · speroni@speronispa.com
Showrooms · Italy · Usa · Japan · Germany · Switzerland · England
India · France · Spain · Russia